

Prices effective from 1st April 2026



Spraying Equipment

Product Guide 2026-27

silvan.com.au



Contents



AIR ASSIST SPRAYERS

Linkage Suntuff	6
1000L Compact Supaflo	7
Oktopus Sprayer	8
1500/2000L Supaflo.....	9
2000L Stiletto.....	10
2000L Stiletto Antis.....	11
3500L Supaflo.....	12
4000L G2E Supaflo.....	13
4000L G2 Supaflo.....	14
5000L Supaflo.....	15
TTS.....	16
Cannon Jet.....	17
Sprayer Options.....	18
Powerhead Conveyer.....	20
SCRAM Jet/AVOJet.....	20
Radak Conveyer	21



TURBOMISER SPRAYERS

400L P42E/P45E.....	24
600L P50E.....	25
600L P55DS.....	26
600L P55DS Airboom.....	27
1500/2000L P50E.....	28
2000/3500L P55DS	29
Turbomiser Heads	30



OVERROW SPRAYERS

TGS.....	34
Turbomiser.....	35
TurboSCRAM	36
SCRAM X.....	37
Overrow Sprayer Options ..	38

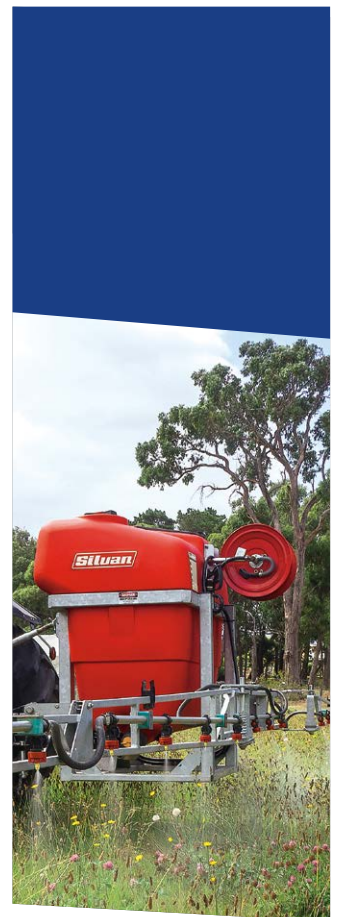

LINKAGE SPRAYERS

400L Redlink.....	41
300/400/600L EconoPak.....	42
400/600/800L PasturePak	43
800/1000L EconoMax.....	44
400/600L SuperPak.....	45
400/600L Super Series	46
800/1100L Super Series	47
1300/1600/1900L Super Series	48
1300/1600/1900L Spray Pro.....	49
200/300/400L Slimline Series	50
800/1000L Slimline Series	51
600/800/1100L Cane Boom	52
600/800/1100L Casotti	53



BOOMS & ACCESSORIES

Vineyard & Orchard Booms	55
Field & Cane Booms	56
Hydraulic Booms	57
Silmix, Foam Markers & Hosereels	58



TRAILED & SLED SPRAYERS

2500/3000L Paddock Pak	60
2500/3000L Pasture Sprayer	61
1000/2000L Paddockmaster Sprayer	62
1000/2000L Turf Sprayer ..	63
400L Tray Mount Turf Sprayer	64
2000L Orchard Herbicide Sprayer	65



SPRAY CONTROLLERS & ACCESSORIES

Guidance Systems & Spray Rate Controllers ..	67
Bravo 180S Spray Rate Controllers	68
Rate Controller Valve Kits	68
IOTBOX2	69
ISOBUS Controllers	69
Electric Control Kits	70
Hydraulic Drive Centrifugal Pumps	71
High Pressure Pumps	72



SPRAY INFORMATION

Horticulture Nozzles	74
Boomless Nozzles	75
Choosing The Right Pump ..	75
Nozzle Selection & Output Chart	76
Terms and Conditions	78

Air Assist Sprayers

Silvan's range of Air Assist Sprayers have been developed to meet the needs of growers for greater efficiency, safety and spray performance.



Designed for professional agricultural use in orchards and vineyards, Silvan's air assist sprayers are fitted with reliable and highly efficient air delivery systems.

The axial flow fan produces a high volume of air directed deep into the canopy while avoiding damage to fruit or blooms. Canopy penetration is not a question of air velocity, but being able to displace the air that is already in place, in and around the foliage.

Non-drip flip-over nozzles are accurately positioned within the airstream to direct the atomised spray into the canopy, creating an even and consistent droplet size.

This improved airstream penetrates to the heart of the canopy and reaching the highest parts of the tree. It provides excellent coverage of upper and lower leaf surfaces.

Single or two speed gearbox with neutral position for air volume adjustment.

Controls are simple and easy to use.

Brass head high pressure diaphragm pumps fitted as standard on trailed units.

Hand wash tank on trailed models.

Polytuff UV stabilised, impact resistant tank.

Galvanised chassis & frame for longer working life.

Wide range of wheels to suit application and soil conditions.

Trailed units available with single (fixed or suspension) axle or tandem suspension axle for increased stability.



The axial flow fan has been designed with curved blades to substantially increase performance while using less horsepower. Blade pitch can be easily adjusted to obtain the desired performance.

Linkage Suntuff



Orchards



Vineyards



Pictured: 200L Suntuff with two-sided deflector

MODEL SPECIFICATIONS

PUMP	Silvan oil-backed diaphragm type with nitrile diaphragms and corrosion resistant, cast anodised aluminium body. APS71: 67L/min. capacity 5000kPa pressure APS96: 88L/min. capacity 5000kPa pressure.	TANK	Polytuff, impact resistant, polyethylene construction with litre calibrations, non-spill screw-down lid.			
FAN SIZE	Axial flow type, fan with curved nylon reinforced blades, galvanised cowling and protective mesh cover. 600mm with 8 blades on 200L unit 700mm with 8 blades on 400L unit 800mm with 10 blades on 500L unit	FRAME	Galvanised steel, suit cat I & II linkage (200L cat I linkage only)			
NOZZLES	Flip-over type for dilute/concentrate spraying, ceramic jets, stainless steel swirl-plates. 200L unit: 10 single nozzles (5 per side) twist on/off 400L unit: 12 flip over nozzles (6 per side) twist on/off 500L unit: 14 flip over nozzles (7 per side) twist on/off	AGITATION	200L: bypass, 400L / 500L: dual bypass			
GEARBOX	Single-speed with neutral position, oil-bath type.	PRESSURE GAUGE	Glycerine filled gauge, located on the control valve.			
CONTROLS	3 outlet with pressure regulator. 400/500L models standard with extra length hoses - for tractor control mount.	FILTRATION	Lid strainer, suction line strainer and stainless steel nozzle filters.			
		PTO DRIVESHAFT	Quality driveshaft with quick release pins & safety cover.			
		HP REQUIRED	200L: Min. 20 PTO HP, 400L: Min. 40 PTO HP, 500L: Min. 50 PTO HP.			
		DIMENSIONS	L (MM)	W (MM)	H (MM)	KG (DRY)
		D026-71	1070	1000	1060	90
		D047-71	1330	1190	1200	134
		D058-96	1400	1190	1325	140

MODEL DESCRIPTION	CODE	PRICE EX. GST	PRICE INC. GST	
200L SUNTUFF: APS71 pump, 600mm fan	D026-71	\$8,950	\$9,845	
400L SUNTUFF: APS71 pump, 700mm fan	D047-71	\$10,490	\$11,539	
400L SUNTUFF: APS71 pump, 700mm fan, electric controls	D047-71E	\$12,790	\$14,069	
500L SUNTUFF: APS96 pump, 800mm fan	D058-96	\$11,200	\$12,320	
500L SUNTUFF: APS96 pump, 800mm fan, electric controls	D058-96E	\$13,500	\$14,850	
DEALER FITMENT OPTIONS	FAN SIZE (MM)	CODE	PRICE EX. GST	PRICE INC. GST
Two - sided deflector	600	D99-98	\$300	\$330
Two - sided deflector	700	D99-92B	\$400	\$440
Two - sided conveyor	700/800	D99-177	\$4,090	\$4,499
Two - sided deflector	800	D99-100	\$360	\$396
Bottom air deflectors	600/700/800	D99-63	\$350	\$385

Note: Not all options will fit all models. Extra charges may apply to fitment of some options.

1000L Compact Supaflo



Pictured: 1000L Compact Supaflo with two-sided conveyor

MODEL SPECIFICATIONS

PUMP	Silvan oil-backed diaphragm type with nitrile diaphragms and corrosion resistant, cast anodised aluminium body with brass heads and manifold. IDS960:93L/min. capacity, 5000kPa pressure. IDS1401:135L/min. capacity, 5000kPa pressure.
FAN SIZE	700mm axial flow type, 8 bladed fan (or 800mm with 10 blades) with curved nylon reinforced blades and protective mesh cover.
NOZZLES	Flip-over type for dilute/concentrate spraying. Ceramic HCl nozzles. 12 double sided nozzles (6 per side) twist on/off (7 per side on 800mm fan).
GEARBOX	Single speed with neutral position, oil-bath type.
CONTROLS	40 Bar electric section valves, master valve, electric pressure regulator and in-cab controls.
MAIN TANK	Polytuff impact resistant polyethylene construction, calibrated sight line, flip-top easy open lid, 40mm drain valve.
FLUSH TANK	80L flush tank with top fill. Used to flush pump, filter, spray lines and nozzles.

HAND WASH TANK	15L fresh water hand wash tank.			
FRAME	Galvanised steel with jockey wheel and adjustable drawbar.			
AGITATION	Pump bypass plus venturi agitator.			
PRESSURE GAUGE	100mm, 0-60 bar glycerine filled gauge with bar increments.			
FILTRATION	Lid strainer and suction line filter.			
WHEEL EQUIPMENT	50mm axle with 15" tubeless tyres on painted rims (speed rating 30 km/h).			
PTO DRIVESHAFT	Quality driveshaft with quick release pins and safety cover.			
HP REQUIRED	Minimum 40 PTO HP.			
DIMENSIONS	L (MM)	W (MM)	H (MM)	KG (DRY)
AB11AF8R	2860	1100	1500	300
	Length measured with drawbar in shortest position.			

MODEL DESCRIPTION	CODE	PRICE EX. GST	PRICE INC. GST
1000L COMPACT SUPAFLO: IDS960 pump, 700mm fan & electric valve controls	AB11AF8R	\$24,500	\$26,950
FACTORY OPTIONS	CODE	PRICE EX. GST	PRICE INC. GST
IDS1401 pump, 135L/min. capacity, 5000kPa pressure,	D99-179	\$1,500	\$1,650
800mm fan (in lieu)	D99-188	\$1,250	\$1,375
Two-sided deflector (700mm fan)	D99-92B	\$400	\$440
Two-sided conveyor (700 + 800mm fan - 7 nozzles per side)	D99-177	\$4,090	\$4,499
Bottom air deflectors	D99-63	\$350	\$385
Wide axle (1650mm)	D99-181	\$850	\$935
Spray Rate automatic rate controller	D99-144	\$4,500	\$4,950
Bravo 180S automatic rate controller	D99-143	\$6,000	\$6,600

Extra charges may apply to fitment of some options.

Oktopus Sprayer



Berries



Vineyards



Pictured: 2000L Oktopus

MODEL SPECIFICATIONS

PUMP	Silvan oil-backed diaphragm type with nitrile diaphragms, corrosion resistant, cast anodised aluminium body. APS96: 88L/min. capacity, 5000kPa pressure IDS960: 93L/min capacity, 5000kPa pressure. APS121:115L/min capacity, 5000kPa pressure.			
	FAN SIZE	450mm diameter turbine fan, 10 fishtail outlets.		
NOZZLES	Flip-over type for dilute/concentrate spraying with ceramic hollow cone nozzles.10 nozzles (5 per side) twist on/off.			
GEARBOX	Two speed with neutral position, oil-bath type.			
CONTROLS	40 bar electric section valves, master valve, electric pressure regulator and in cab controls.			
TANK	Polytuff impact resistant polyethylene construction, calibrated sight line, non-spill lid. 80L flush tank and 15L hand wash tank fitted to 1000L unit. 40 litre fresh water tank fitted to 2000L unit.			
FRAME	500L: Galvanised steel, suit cat I & II linkage 1000 and 2000L: Galvanised steel with jockey wheel and adjustable drawbar.			
AGITATION	500L: Dual bypass. 1000 and 2000L: Pump bypass plus venturi agitator.			
PRESSURE GAUGE	63mm, 0-60 bar glycerine filled gauge (500L unit)			
FILTRATION	Lid strainer and suction line strainer.			
TRAILED WHEEL EQUIPMENT	1000L: 50mm axle with 15" tubeless tyres on painted rims. 2000L: Glideflex suspension axle, 2 x 15" tubeless tyres on painted rims (max speed rating 30 km/h).			
PTO DRIVESHAFT	Quality driveshaft with quick release pins and safety cover.			
HP REQUIRED	Minimum 50PTO HP.			
DIMENSIONS	L (MM)	W (MM)	H (MM)	KG (DRY)
D05SLV-96	1400	1190	2325	250
AB11NF8R	2860	1540	2500	350
D20SLV-121EGL	3750	1540	2500	640

Length measured with drawbar in shortest position.

MODEL DESCRIPTION	CODE	PRICE EX. GST	PRICE INC. GST
500L LINKAGE OKTOPUS: APS96 pump, Oktopus fan, electric valve controls	D05SLV-96	\$22,500	\$24,750
1000L TRAILED OKTOPUS: IDS960 pump, Oktopus fan, electric valve controls	AB11NF8R	\$34,990	\$38,489
2000L TRAILED OKTOPUS: APS121 pump, Oktopus fan, electric valve controls, Glideflex axle	D20SLV-121EGL	\$36,290	\$39,919

FACTORY OPTIONS REFER TO PAGE 19

1500/2000L Supaflo



Orchards



Vineyards



FOR MORE INFORMATION ON THE RADAK CONVEYOR SEE PAGE 21

Pictured: 2000L Supaflo

MODEL SPECIFICATIONS

PUMP	Silvan oil-backed diaphragm type with nitrile diaphragms and corrosion resistant, cast anodised aluminium body with brass heads and manifold. IDS1701:161L/min. capacity, 5000kPa pressure.	FRAME	Galvanised steel with jockey wheel & adjustable drawbar.			
FAN SIZE	900mm axial flow type, 10 bladed fan with curved nylon reinforced blades, air straightening vanes and protective mesh cover. Powerhead (920mm) & Radak (1000mm) fitted with 10 bladed axial flow fan, centrifugal clutch and protective mesh cover.	AGITATION	Pump bypass plus venturi agitator.			
NOZZLES	Flip-over type for dilute/concentrate spraying. Ceramic jets, stainless steel swirl-plates. 16 double sided nozzles (8 per side) twist on/off. The Powerhead has 24 double sided nozzles (12 per side) and the Radak has 32 (16 per side).	PRESSURE GAUGE	100mm, 0-60 bar glycerine filled gauge.			
GEARBOX	2-speed with neutral position, oil-bath type.	FILTRATION	Lid strainer, suction line strainer & stainless steel nozzle filters.			
CONTROLS	40 bar electric section valves, master valve, electric pressure regulator and in cab controls.	WHEEL EQUIPMENT	Glideflex suspension axle, 2 x 15" tubeless tyres on painted rims (max speed rating 30 km/h).			
TANK	Polytuff impact resistant polyethylene construction, calibrated sight line, flip-top easy open lids, 40mm drain valve and built-in chemical mixer. 40L fresh water hand wash tank.	PTO DRIVESHAFT	Quality Bondioli & Pavesi constant velocity driveshaft with quick release pins & safety cover.			
		HP REQUIRED	Minimum 60 PTO HP.			
		DIMENSIONS	L (MM)	W (MM)	H (MM)	KG (DRY)
		DAB153AF8G	3430	1540	1530	540
		DAB23AF8G	3540	1540	1530	540
		Length measured with drawbar in shortest position.				

MODEL DESCRIPTION	CODE	PRICE EX. GST	PRICE INC. GST
1500L SUPAFLO: IDS1701 pump, 900mm fan, electric valve controls, wide angle shaft & Glideflex axle	DAB153AF8G	\$32,250	\$35,475
2000L SUPAFLO: IDS1701 pump, 900mm fan, electric valve controls, wide angle shaft & Glideflex axle	DAB23AF8G	\$32,950	\$36,245

FACTORY OPTIONS REFER TO PAGE 19

2000L Stiletto



Orchards



Vineyards



Pictured: 2000L Stiletto with optional flotation tyres

MODEL SPECIFICATIONS

PUMP	Silvan oil-backed diaphragm type with nitrile diaphragms and corrosion resistant, cast anodised aluminium body with brass heads and manifolds. IDS1701: 161L/min. capacity 5000kPa pressure.	FRAME	Galvanised steel with jockey wheel & adjustable drawbar.			
FAN SIZE	900mm axial flow type, 10 bladed fan with curved nylon reinforced blades, air straightening vanes and protective mesh cover.	AGITATION	Pump bypass plus venturi agitator.			
NOZZLES	Flip-over type for dilute/concentrate spraying. Ceramic jets, stainless steel swirl-plates, 16 nozzles with twist on/off.	PRESSURE GAUGE	100mm, 0-60 bar glycerine filled gauge.			
GEARBOX	Oil-bath type, 2-speed with neutral position.	FILTRATION	Lid strainer, suction line strainer and stainless steel nozzle filters.			
CONTROLS	40 bar electric section valves, master valve, electric pressure regulator and in cab controls.	WHEEL EQUIPMENT	Glideflex suspension axle, 2 x 15" tubeless tyres on painted rims (max speed rating 30 km/h).			
TANK	Polytuff impact resistant polyethylene construction, calibrated sight line, easy open lid, 40mm drain valve and built-in 15L fresh water tank.	PTO DRIVESHAFT	Quality Bondioli & Pavesi constant velocity driveshaft with quick release pins & safety cover.			
		HP REQUIRED	Minimum 60 PTO HP.			
		DIMENSIONS	L (MM)	W (MM)	H (MM)	KG (DRY)
		DST23AF8G	3800	1540	1500	640
			Length measured with drawbar in shortest position.			

MODEL DESCRIPTION	CODE	PRICE EX. GST	PRICE INC. GST
2000L STILETTO: IDS1701 pump, 900mm fan, electric valve controls, Glideflex axle, wide angle shaft	DST23AF8G	\$32,950	\$36,245

FACTORY OPTIONS REFER TO PAGE 19

2000L Stiletto Antis



Orchards



Vineyards



**FRONT
INTAKE
FAN**

Pictured: 2000L Stiletto Antis

MODEL SPECIFICATIONS

PUMP	Silvan oil-backed diaphragm type with nitrile diaphragms and corrosion resistant, cast anodised aluminium body with brass heads and manifolds. IDS1701: 161L/min. capacity 5000kPa pressure.			
FAN SIZE	913mm axial flow type, 9 bladed front intake fan with straight blades, centrifugal clutch for soft engagement/disengagement and protective mesh cover.			
NOZZLES	14 flip-over nozzle bodies for dilute/concentrate spraying with on/off. 7 ceramic hollow cone nozzles per side.			
GEARBOX	Oil-bath type, 2-speed with neutral position.			
CONTROLS	40 bar electric section valves, master valve, electric pressure adjustment and in cab control.			
TANK	Polytuff impact resistant polyethylene construction, calibrated sight line, easy open lid, 40mm drain valve, built-in 15L fresh water tank.			
FRAME	Galvanised steel with jockey wheel and adjustable drawbar.			
AGITATION	Pump bypass plus venturi agitator.			
PRESSURE GAUGE	100mm, 0-60 bar glycerine filled gauge.			
FILTRATION	Lid strainer, suction line strainer and stainless steel nozzle filters.			
WHEEL EQUIPMENT	Glideflex suspension axle with 15" tubeless tyres on painted rims (max speed rating 30 km/h).			
PTO DRIVESHAFT	Quality Bondioli & Pavesi constant velocity driveshaft with quick release pins & safety cover.			
HP REQUIRED	Minimum 60 PTO HP.			
DIMENSIONS	L (MM)	W (MM)	H (MM)	KG (DRY)
DST23PF8G	4100	1700	1500	690
	Length measured with drawbar in shortest position.			

MODEL DESCRIPTION

2000L STILETTO ANTIS: IDS1701 pump, 913mm Antis fan, electric valve controls, Glideflex axle, wide angle shaft

CODE

DST23NF8G

PRICE EX. GST

\$40,070

PRICE INC. GST

\$44,077

FACTORY OPTIONS REFER TO PAGE 19

3500L Supaflo



Orchards



Pictured: 3500L Supaflo with optional Powerhead conveyor

MODEL SPECIFICATIONS

PUMP	Silvan oil-backed diaphragm type with nitrile diaphragms and corrosion resistant, anodised cast aluminium body with brass heads and manifolds.	FRAME	Galvanised steel with jockey wheel and adjustable drawbar.			
	IDS1701: 161L/min. capacity, 5000kPa pressure. IDS2600: 249L/min. capacity, 5000kPa pressure.		AGITATION	Pump bypass plus venturi agitator.		
FAN SIZE	900mm axial flow type, 10 bladed fan with curved nylon reinforced blades with air straightening vanes and protective mesh cover. Powerhead (920mm) & Radak (1000mm) fitted with 10 bladed axial flow fan, centrifugal clutch and protective mesh cover.	PRESSURE GAUGE	Glycerine filled gauge located on valve bank.			
	NOZZLES	FILTRATION	Lid strainer, suction line filter and nozzle cup strainers.			
GEARBOX	Flip-over type for dilute/concentrate spraying. Ceramic jets, stainless steel swirl-plates. 16 double sided nozzles (8 per side) twist on/off. The Powerhead has 24 double sided nozzles (12 per side) and the Radak has 32 (16 per side).	WHEEL EQUIPMENT	Glideflex suspension axle fitted with 16" tyres and painted rims (speed rating 30km/h).			
	CONTROLS	PTO DRIVESHAFT	Quality Bondioli & Pavesi constant velocity driveshaft with quick release pins & safety cover.			
TANK	Polytuff impact resistant polyethylene construction, calibrated sight line, built-in chemical mixer and 40L fresh water hand wash tank. Camlock bottom fill.	HP REQUIRED	Minimum 80 PTO HP.			
		DIMENSIONS	L (MM)	W (MM)	H (MM)	KG (DRY)
		DAB33AF7G	4755	1830	1800	800
			Length measured with drawbar in shortest position.			

MODEL DESCRIPTION	CODE	PRICE EX. GST	PRICE INC. GST
3500L SUPAFLO: IDS1701 pump, 900mm fan, electric valve controls, Glideflex axle	DAB33AF7G	\$38,500	\$42,350

FACTORY OPTIONS REFER TO PAGE 19

4000L G2E Supaflo



Pictured: 4000L G2E with Radak and optional Avo Jet

MODEL SPECIFICATIONS

PUMP	Silvan oil-backed diaphragm type with nitrile diaphragms and corrosion resistant, cast aluminium body with brass heads & manifolds. IDS1701:161L/min. capacity, 5000kPa pressure.	CHEMICAL INDUCTION	Venturi suction probe.								
FAN SIZE	920mm or 1000mm axial flow type, 10 bladed fan with curved nylon reinforced blades, centrifugal clutch for soft engagement/ disengagement and protective mesh cover.	FRAME	Galvanised steel, heavy duty stand & adjustable drawbar.								
NOZZLES	24 flip-over nozzle bodies for dilute/concentrate spraying with on/off. 12 Ceramic hollow cone nozzles per side and 12 ceramic jets with stainless steel swirl plates per side. (16 per side with the Radak conveyor).	AGITATION	Pump bypass plus venturi agitator.								
GEARBOX	2-speed with neutral position, oil-bath type.	PRESSURE GAUGE	Glycerine filled gauge located on valve bank.								
CONTROLS	40 Bar electric section valves with master valve, electric pressure regulator and in cab controls.	FILTRATION	Suction line filter, pressure filter, nozzle cup strainers.								
MAIN TANK	Polytuff impact resistant polyethylene construction with calibrated sight line. 50mm Camlock top & bottom fill.	WHEEL EQUIPMENT	Glideflex axle with 13.0/65 - 18" implement tyres (speed rating 30km/h).								
HAND WASH TANK	15L polytuff tank filled through cap. Located next to bottom fill.	PTO DRIVESHAFT	Quality Bondioli & Pavesi constant velocity driveshaft with quick release pins & safety cover.								
		HP REQUIRED	Minimum 80 PTO HP (920mm fan), minimum 90 PTO HP (1000mm fan).								
		DIMENSIONS	<table border="1"> <thead> <tr> <th>L (MM)</th> <th>W (MM)</th> <th>H (MM)</th> <th>KG (DRY)</th> </tr> </thead> <tbody> <tr> <td>5300</td> <td>1880</td> <td>2020</td> <td>1220</td> </tr> </tbody> </table>	L (MM)	W (MM)	H (MM)	KG (DRY)	5300	1880	2020	1220
L (MM)	W (MM)	H (MM)	KG (DRY)								
5300	1880	2020	1220								
		EAB43PF2G	Length measured with drawbar in shortest position.								

MODEL DESCRIPTION	CODE	PRICE EX. GST	PRICE INC. GST
4000L G2E SUPAFLO: IDS1701 pump, 920mm Powerhead fan, electric valve controls, Glideflex axle	EAB43PF2G	\$50,500	\$55,550
4000L G2E SUPAFLO: IDS1701 pump, 1000mm Radak fan, electric valve controls, Glideflex axle	EAB43RF2G	\$56,650	\$62,315

FACTORY OPTIONS REFER TO PAGE 19

4000L G2 Supaflo



Orchards



Pictured: 4000L G2 Supaflo with Radak

MODEL SPECIFICATIONS

PUMP	Silvan oil-backed diaphragm type with nitrile diaphragms and corrosion resistant, cast aluminium body with brass heads and manifolds. IDS1701:161L/min. capacity, 5000kPa pressure.	HAND WASH TANK	60L polytuff tank filled through cap. Tap located next to chemical mixer hopper.			
FAN SIZE	920mm or 1000mm axial flow type, 10 bladed fan with curved nylon reinforced blades, centrifugal clutch for soft engagement/ disengagement and protective mesh cover.	MIXER TANK	Chemical mixer hopper with tap controls for rinse, transfer and main tank rinse. Venturi transfer back to main tank.			
NOZZLES	24 flip-over nozzle bodies for dilute/concentrate spraying with on/off. 12 Ceramic hollow cone nozzles per side and 12 ceramic jets with stainless steel swirl plates per side. (16 per side with the Radak conveyor).	FRAME	Galvanised steel, heavy duty stand & adjustable drawbar.			
GEARBOX	2-speed with neutral position, oil-bath type.	AGITATION	Pump bypass plus venturi agitator.			
CONTROLS	40 Bar electric section valves with master valve, electric pressure regulator and in cab controls.	PRESSURE GAUGE	Glycerine filled gauge located on valve bank.			
MAIN TANK	Polytuff impact resistant polyethylene construction with calibrated sight line. 50mm Camlock top & bottom fill.	FILTRATION	Suction line filter, pressure filter, nozzle cup strainers.			
FLUSH TANK	330L polytuff tank with top fill. Used to flush pump, filter, spray lines and nozzles.	WHEEL EQUIPMENT	Glideflex axle with 13.0/65 - 18" implement tyres (speed rating 30km/h).			
		PTO DRIVESHAFT	Quality Bondioli & Pavesi constant velocity driveshaft with quick release pins & safety cover.			
		HP REQUIRED	Minimum 80 PTO HP (920mm fan), minimum 90 PTO HP (1000mm fan).			
		DIMENSIONS	L (MM)	W (MM)	H (MM)	KG (DRY)
		AB43PE2G	5550	1880	2020	1400
			Length measured with drawbar in shortest position.			

MODEL DESCRIPTION	CODE	PRICE EX. GST	PRICE INC. GST
4000L G2 SUPAFLO: IDS1701 pump, 920mm Powerhead fan, electric valve controls, Glideflex axle	AB43PE2G	\$63,250	\$69,575
4000L G2 SUPAFLO: IDS1701 pump, 1000mm Radak fan, electric valve controls, Glideflex axle	AB43RE2G	\$69,500	\$76,450

FACTORY OPTIONS REFER TO PAGE 19

5000L Supaflo



Pictured: 5000L Radak

MODEL SPECIFICATIONS

PUMP	Silvan oil-backed diaphragm type with nitrile diaphragms and corrosion resistant, cast aluminium body with brass heads & manifolds. IDS1701:161L/min. capacity, 5000kPa pressure.	CHEMICAL INDUCTION	Venturi suction probe.			
FAN SIZE	920mm or 1000mm axial flow type, 10 bladed fan with curved nylon reinforced blades, centrifugal clutch for soft engagement/disengagement and protective mesh cover.	FRAME	Galvanised steel, heavy duty stand & adjustable drawbar.			
NOZZLES	24 flip-over nozzle bodies for dilute/concentrate spraying with on/off. 12 Ceramic hollow cone nozzles per side and 12 ceramic jets with stainless steel swirl plates per side. (16 per side with the Radak conveyor).	AGITATION	Pump bypass plus venturi agitator.			
GEARBOX	2-speed with neutral position, oil-bath type.	PRESSURE GAUGE	Glycerine filled gauge located on valve bank.			
CONTROLS	40 Bar electric section valves with master valve, electric pressure regulator and in cab controls.	FILTRATION	Suction line filter, pressure filter, nozzle cup strainers.			
MAIN TANK	Polytuff impact resistant polyethylene construction with calibrated sight line. 50mm Camlock bottom fill.	WHEEL EQUIPMENT	Glideflex axle with 558-400/60 - 22.5" flotation tyres (speed rating 30km/h).			
HAND WASH TANK	15L polytuff tank filled through cap. Located on right hand side.	PTO DRIVESHAFT	Quality Bondioli & Pavesi constant velocity driveshaft with quick release pins & safety cover.			
		HP REQUIRED	Minimum 95 PTO HP.			
		DIMENSIONS	L (MM)	W (MM)	H (MM)	KG (DRY)
		AB73PF2G	5400	1880	2300	1220
			Length measured with drawbar in shortest position.			

MODEL DESCRIPTION	CODE	PRICE EX. GST	PRICE INC. GST
5000L SUPAFLO: IDS1701 pump, 920mm Powerhead fan, electric valve controls, Glideflex axle	AB73PF9G	\$64,350	\$70,785
5000L SUPAFLO: IDS1701 pump, 1000mm Radak fan, electric valve controls, Glideflex axle	AB73RF9G	\$72,500	\$79,750

FACTORY OPTIONS REFER TO PAGE 19

TTS Sprayer



Orchards



Pictured: 3500L TTS

MODEL SPECIFICATIONS

PUMP	Silvan oil-backed diaphragm type with nitrile diaphragms, corrosion resistant, cast anodised aluminium body. IDS1701: 161L/min capacity, 5000kPa pressure.	AGITATION	Pump bypass plus venturi agitator.			
FAN SIZE	Dual 450mm diameter twin turbine fans with galvanised frame and spray head. Hydraulic angle adjustment and manual top wing adjustment.	PRESSURE GAUGE	100mm, 0-60 bar glycerine filled gauge with bar increments.			
NOZZLES	Flip-over type with ceramic hollow cone nozzles. 11 nozzles (6 in cannon head, 5 in side of cannon) with twist on/off per cannon.	FILTRATION	Lid strainer, suction line strainer and nozzle filters.			
GEARBOX	Two speed with neutral position, oil-bath type.	WHEEL EQUIPMENT	Glideflex suspension axle fitted with 11.00 x 16" (3500L) or 13.0/65 - 18" (4000L) wheels (speed rating 30km/h).			
CONTROLS	40 bar electric section valves, master valve, electric pressure regulator and in cab controls.	PTO DRIVESHAFT	Quality Bondioli & Pavesi constant velocity driveshaft with quick release pins & safety cover.			
TANK	Polytuff impact resistant polyethylene construction, calibrated sight line, non-spill lid. 15L (4000L) or 40L (3500L) fresh water tank. 50mm Camlock bottom fill.	HP REQUIRED	Minimum 100HP.			
FRAME	Galvanised steel with jockey wheel (3500L) or stand (4000L) & adjustable drawbar.	DIMENSIONS	L (MM)	W (MM)	H (MM)	KG (DRY)
		D30JET-1701GLT	5005	1830	3100	900
		D40JET-1701GLT	5550	1880	3100	1320

Length measured with drawbar in shortest position.

MODEL DESCRIPTION	CODE	PRICE EX. GST	PRICE INC. GST
3500L TTS: IDS1701 pump, Twin jet fan, electric valve controls, Glideflex axle	D30JET-1701GLT	\$83,950	\$92,345
4000L TTS: IDS1701 pump, Twin jet fan, electric valve controls, Glideflex axle	D40JET-1701GLT	\$86,500	\$95,150

FACTORY OPTIONS REFER TO PAGE 19

Cannon Jet



Strawberries



Flowers



Parks & Gardens



Vegetables



Greenhouse



MODEL SPECIFICATIONS

PUMP	Silvan oil-backed diaphragm type with nitrile diaphragms, corrosion resistant, cast anodised aluminium body. APS96: 88L/min. capacity, 5000kPa pressure IDS1701: 161L/min capacity, 5000kPa pressure.				
FAN SIZE	450mm diameter twin turbine fan with galvanised frame and spray head. Hydraulic angle adjustment and manual top wing adjustment.				
NOZZLES	Flip-over type with ceramic hollow cone nozzles. 9 nozzles (6 in cannon head, 3 in side of cannon) with twist on/off.				
GEARBOX	Two speed with neutral position, oil-bath type.				
CONTROLS	40 bar electric section valves, master valve, electric pressure regulator and in cab controls.				
TANK	Polytuff impact resistant polyethylene construction, calibrated sight line, non-spill lid. 40 litre fresh water tank fitted to 2000L unit.				
FRAME	500L: Galvanised steel, suit cat I & II linkage 2000L: Galvanised steel with jockey wheel & adjustable drawbar.				
AGITATION	500L: Dual bypass 2000L: Pump bypass plus venturi agitator.				
PRESSURE GAUGE	100mm, 0-60 bar glycerine filled gauge with bar increments.				
FILTRATION	Lid strainer, suction line strainer and stainless steel nozzle filters.				
2000L WHEEL EQUIPMENT	Glideflex suspension axle, 2 x 15" tubeless tyres on painted rims (max speed rating 30 km/h).				
PTO DRIVESHAFT	Quality driveshaft with quick release pins and safety cover. Constant velocity shaft on 2000L trailed.				
HP REQUIRED	Minimum 75HP.				
DIMENSIONS	L (MM)	W (MM)	H (MM)	KG (DRY)	
D05JET-96	1400	1190	2500	140	
D20JET-1701GL	3750	1540	2500	640	

Length measured with drawbar in shortest position.

MODEL DESCRIPTION	CODE	PRICE EX. GST	PRICE INC. GST
500L LINKAGE CANNON JET: APS96 pump, Cannon jet fan, electric valve controls	D05JET-96	\$23,700	\$26,070
2000L TRAILED CANNON JET: IDS1701 pump, Cannon jet fan, electric valve controls, Glideflex axle	D20JET-1701GL	\$38,490	\$42,339
FACTORY OPTIONS	CODE	PRICE EX. GST	PRICE INC. GST
Spray Rate automatic rate controller	D99-144	\$4,500	\$4,950
Bravo 180S automatic rate controller	D99-143	\$6,000	\$6,600

Extra charges may apply to fitment of some options.

Sprayer Options



Spray Rate Controller



Bravo 180S



Quick Turning Hitch



Double Sided Vineyard Conveyor

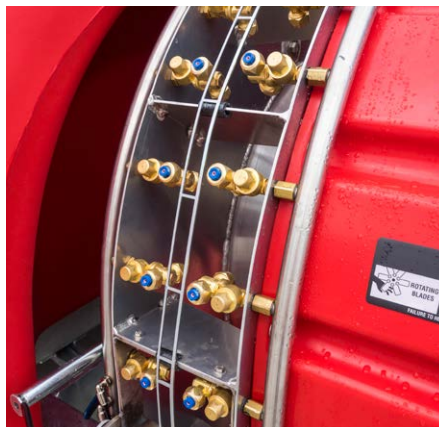

Double Spray Lines



Leaf Guard



Tandem Suspension System



Glideflex Suspension System



31/10.5 X 15"



400/60 X 15.5"



11.5/80 X 15.3"



11.00 X 16"



13.0/65 X 18"



58-400/60 X 22.5"

Wheels & Tyres

Sprayer Options

FACTORY OPTIONS	MODEL DESCRIPTION									CODE	PRICE EX. GST	PRICE INC. GST
	OKTOPUS	1500/2000L SUPAFLO	STILETTO	STILETTO ANTIS	3500L SUPAFLO	4000L G2E	4000L G2	5000L SUPAFLO	TTS			
Spray Rate automatic rate controller										D99-144	\$4,500	\$4,950
Bravo 180S automatic rate controller										D99-143	\$6,000	\$6,600
Quick turning hitch	2000L ONLY									D99-170	\$3,990	\$4,389
IDS2001 pump, 182L/min. capacity, 5000kPa pressure										D99-148	\$1,400	\$1,540
IDS2600 pump, 249L/min. capacity, 5000kPa pressure										D99-149	\$4,950	\$5,445
Hydraulic drive pump	2000L ONLY									D99-150	\$5,000	\$5,500
Narrow Oktopus fan										D99-82	\$3,000	\$3,300
Two-sided poly vineyard conveyor										D99-111	\$2,900	\$3,190
Powerhead Conveyor with tall top wings (920mm fan)										D99-184	\$8,700	\$9,570
Powerhead Conveyor with tall top wings										D99-192	\$8,900	\$9,790
Radak Conveyor - Manual adjustment of top and bottom wings (1000mm fan)										D99-135	\$15,500	\$17,050
Hydraulic kit for Radak Conveyor (top wings)										D99-155B	\$2,500	\$2,750
SCRAM Jet (to suit Radak Conveyor)										D99-180	\$9,500	\$10,450
AVO Jet (to suit Radak conveyor)										D99-187	\$24,500	\$26,950
Leaf guard (to suit Powerhead & Radak)										D99-175	\$4,000	\$4,400
Twin nozzle with extra nozzles (per nozzle)										D99-97	\$50	\$55
Double spray lines (to suit Powerhead - includes extra nozzles and upgrade to 1000mm fan)										D99-189	\$2,750	\$3,025
Double spray lines (Radak)										D99-190	\$3,250	\$3,575
Flotation tyres - 400/60 x 15.5" with fixed axle	2000L ONLY									D99-81	\$2,750	\$3,025
Flotation tyres - 558-400/60 - 22.5 (in lieu of standard)										D99-79	\$3,500	\$3,850
Tandem suspension axle with 10 x 15" wheels									3500L ONLY	D99-75	\$3,100	\$3,410
Tandem suspension axle with 11.5/80 - 15.3" tyres										D99-78	\$6,250	\$6,875
Tandem suspension axle with 13.0/65 - 18" implement tyres									4000L ONLY	D99-191	\$9,900	\$10,890

Extra charges may apply to fitment of some options.

Powerhead Conveyor



The Powerhead is a revolutionary and efficient air conveyor that produces an adjustable spray-laden air stream to match the shape and height of the canopy. Ideal for spraying apples, pears, almonds, citrus and stone fruit trees with lower canopies.

- Internal vanes to direct the airstream into the canopy which also helps maximise the fan's output
- Small top wings to direct air into the upper canopy
- Lower wings to direct airflow from underneath, opening up the canopy for greater spray penetration
- Stainless steel spraylines with 12 flip over nozzles each side

MODEL SPECIFICATIONS

CONVEYOR	Aluminium construction, double-sided conveyor. Top sections are manually adjustable for tree height, bottom wings adjustable for covering lower branches. Patented Air Volute delivery system.
NOZZLES	Flip-over type for dilute/concentrate spraying. Ceramic hollow cone jets with 24 twist on/off nozzles (12 per side).
SUITED ROW WIDTH	Up to 6 metres.
SUITED TREE HEIGHT	Up to 5 metres.



Pictured: Powerhead conveyor with tall top wings

SCRAM/AVO Jet



Pictured: AVO Jet

The AVO Jet utilises twin axial fans positioned above the top wings of the Radak conveyor while the SCRAM Jet uses a single turbine with an adjustable conveyor. Both systems are hydraulically driven from the tractor remotes. The air stream produced by the fans is directed into the top of the tree canopy to support the Radak conveyor in tall tree applications.

The SCRAM Jet has two nozzles in each adjustable chute fitted with adjustable cannons to produce large droplets from the turbine fan into the tallest canopy. The AVO Jet has eight nozzles per fan mounted to a hydraulically controlled frame which can be lowered for road transport. AVO Jet is available on 4000 & 5000L sprayers only.

Note: Hydraulic return line not supplied with quick connect coupling - recommend connecting directly to tractor return with no restrictions.



Pictured: SCRAM Jet

MODEL SPECIFICATIONS

FAN	Twin 700mm axial fans (AVO Jet) or 320mm turbine fan (SCRAM Jet) hydraulically driven from tractor remotes. Hydraulic drive fans with adjustable flow valve and case drain for return oil flow. Fitted with 12V oil cooler. Required hydraulic oil flow: 60L/min at 80 Bar pressure
CONVEYOR	SCRAM Jet: Adjustable aluminium double sided vanes. AVO Jet: Adjustable axial fans.
NOZZLES	SCRAM Jet: Adjustable cannons (2 per side). AVO Jet: Hollow cone nozzles (8 per side).
SUITED TREE HEIGHT	SCRAM JET: Up to 12 metres (when fitted with Radak). AVO JET: Up to 10 metres (when fitted with Radak).

Radak Conveyor



Growers with taller crop canopies prefer the Radak® conveyor which comes in three options to suit different canopy shapes and sizes.

The patented air volute design maximises the use of the airflow generated by the 1000mm fan, the Radak ensures thorough coverage of the targeted canopy by directing airflow into the foliage from underneath via the bottom wings. The venturi effect opens up the tree canopy to aid spray penetration and coverage.

Ideal for tall tree crops throughout Australia such as macadamias, avocados, mangoes, olives, citrus and lychees.

MODEL SPECIFICATIONS

CONVEYOR

Aluminium construction, double-sided conveyor. Top sections via manual or hydraulic operation adjustable for tree height, bottom wings lift for transport. Patented Air Volute delivery system.

NOZZLES

Flip-over type for dilute/concentrate spraying. Ceramic hollow cone jets with 32 twist on/off nozzles (16 per side).



STANDARD RADAK

Code: D99-135
Row width: Up to 8m
Tree height: Up to 8m



TALL TOP RADAK- STD BOTTOM WINGS

Code: D99-135T
Row width: Up to 8m
Tree height: Up to 10m

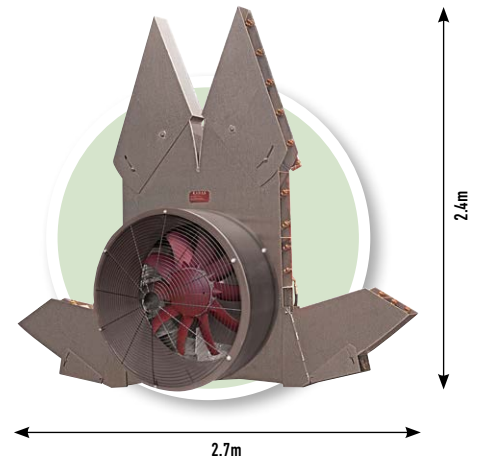

TALL TOP RADAK- WIDE BOTTOM WINGS

Code: D99-135TW
Row width: Up to 10m
Tree height: Up to 10m

Turbomisers

The Turbomiser utilises the best air shear technology to achieve optimum spray coverage using less water. A range of spray heads are available to suit the application.

The Turbomiser is a highly advanced, low volume, air shear sprayer that provides smooth, low maintenance operation. It includes an innovative range of easy to calibrate interchangeable spray heads. Used for a variety of crops including citrus, vines, vegetables, avocados, mangos, apples, pears, strawberries, bananas, stone fruit and macadamias, the Turbomiser can be easily setup up to suit individual agricultural needs.

Since Silvan first launched the Turbomiser in 1983, it has fast become Australia's preferred vineyard sprayer.

It has gained uncontested status amongst major corporate wineries and used by many leading farm managers simply because it is still the most effective crop protection system in the industry.



THE TURBOMISER ADVANTAGE

Silvan's range of Turbomiser sprayers ensure excellent plant coverage and superb pest and disease control with minimal maintenance whilst reducing contamination to the soil and the environment through low volume air shear technology.

Low volume, air shear sprayers can cover the same vegetative surface sprayed by 'dilute volume' machines, but with a much lower quantity of water. As a comparison, a single tank of water used in a Turbomiser could cover up to the same area covered by 3 tanks used in a dilute spray application rate sprayer.

Atomisation of the spray liquid in a Silvan Turbomiser is achieved by introducing the water and chemical mixture into a very powerful air stream through a venturi tube. The air stream then shears the liquid into a narrow range of droplets.

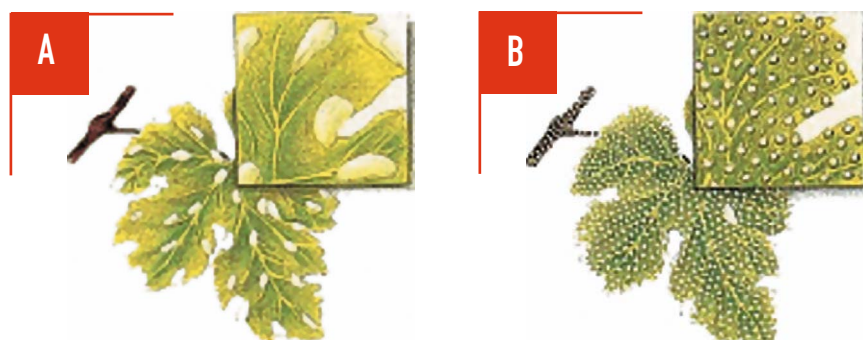

This illustrated comparison demonstrates the likely difference between a vineyard leaf sprayed by a 'Dilute Volume' machine (diagram: A) and Silvan's 'Low Volume' Turbomiser (diagram: B).

Turbomisers atomise the liquid and mix it with the current of air so well that the droplets are carried into the more hidden areas of the plants. With a narrow droplet spectrum it is possible to double, triple or quadruple the number of droplets per square centimetre of vegetative surface while using significantly less water than dilute spray rates. This also causes the droplets to stay on the vegetation instead of running off onto the soil which means you maximise the effect of your spray chemicals.

To achieve complete coverage and thorough contact on the foliage, it is only necessary to replace the air in and around the plant with the air from the low volume sprayer. Since the air and spray are homogeneous, where the air arrives, so does the chemical.

The Silvan Turbomiser "Low Volume" system significantly improves spraying time by its ability to apply chemicals at faster ground speed reducing the number of tank refills and the lost time spent travelling between fills. The time saved can be important in ensuring chemicals are applied to the crop at their optimum efficiency for pest and disease control.



UV stabilised, impact resistant polyethylene tank with a smooth inner surface for easier cleaning and avoiding chemical residue.

Galvanised steel framework and chassis and ensures a longer working life.

Automatic tensioning of the fan drive maintains the belt tension, avoiding slipping and wear.

Low maintenance centrifugal pump



Spray heads available for a range of applications and most crop types.

Simple & low maintenance rotating calibration discs regulate chemical flow to each head.

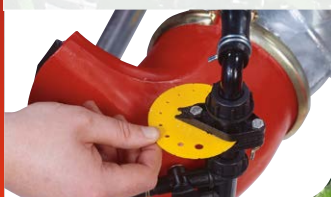

400L Linkage P42E & P45E Turbomiser



Greenhouses



Vineyards

AVAILABLE WITH
TURBOMISER
HEAD OPTIONS
SEE PAGE 30



Pictured: P42E 400L with optional double sided diffuser head



Pictured: P45E 400L with optional Super Cannon head



MODEL SPECIFICATIONS

PUMP	CD32 centrifugal pump 140L/min constructed from toughened nylon. Stainless steel shaft & viton/ceramic seal.	FRAME	Galvanised RHS steel construction, cat II linkage.			
FAN SIZE	P42E: 420 mm dia. turbine fan, 3900 rpm. Power consumed 18 kw / 25HP. P45E: 450 mm dia. turbine fan, 4500 rpm. Power consumed 34 kw / 45HP.	TANK	400L Polytuff impact resistant polyethylene construction, calibrated sight line, non-spill lids, hydro chemical mixer in larger basket, lids with basket strainers, separate in-built 18L fresh water hand wash tank.			
NOZZLES	Air shear.	AGITATION	Bypass and pneumatic.			
CONTROLS	Two sided electric on/off control valves with control box mounted in cabin. Rotary plate distribution regulators with 15 settings and manual pressure adjustment.	PRESSURE GAUGE	Protected 100 mm glycerine gauge fitted at front of sprayer.			
GEARBOX	Multiplication type through multi-grip, multi-vee belt and pulley, over-run free wheeling hub and oil bath fan housing.	FILTRATION	Lid strainer and suction line strainer.			
		PTO DRIVESHAFT	Quality Bondioli & Pavesi driveshaft with quick release pins and safety cover.			
		HP REQUIRED	Minimum 25 PTO HP (P42), 45 PTO HP (P45).			
		GTM-P45N (LESS HEAD)	L (MM)	W (MM)	H (MM)	KG (DRY)
			1000	1100	1150	207

MODEL DESCRIPTION	CODE	PRICE EX. GST	PRICE INC. GST
400L P42E LINKAGE TURBOMISER: P42E fan (spray head not included)	GTM-P42N	\$19,990	\$21,989
400L P45E LINKAGE TURBOMISER: P45E fan (spray head not included)	GTM-P45N	\$22,450	\$24,695
FACTORY OPTIONS	CODE	PRICE EX. GST	PRICE INC. GST
Super cannon for P42E	GT42-1	\$4,500	\$4,950
Super cannon for P45E	GT45-1	\$4,850	\$5,335
Manual turntable for Super Cannon	GT55-4	\$1,900	\$2,090
Hydraulic turntable for Super Cannon	GT55-9	\$4,150	\$4,565
Double sided diffuser head (5 outlets per side) for P42E	GT40-2	\$2,500	\$2,750
Double sided diffuser (5 outlets per side) for P45E	GT45-2	\$2,900	\$3,190
Vineyard head - 4 heads (4x4) for P45E	GT45-11	\$5,650	\$6,215
Bravo 180S automatic rate controller	GT-24	\$6,900	\$7,590

Note: Not all options will fit all models. Extra charges may apply to fitment of some options. Sprayers depicted with optional sprayhead

600L Linkage P50E Turbomiser



Greenhouses



Orchards



Vineyards

AVAILABLE WITH
TURBOMISER
HEAD OPTIONS
SEE PAGE 30



Pictured: P50E 600L with optional vineyard head (GT55-11)

MODEL SPECIFICATIONS

PUMP	CD32 centrifugal pump, 140L/min. constructed from toughened nylon. Stainless steel shaft & viton/ceramic seal.	TANK	600L Polytuff impact resistant polyethylene construction, calibrated sight line, non-spill lids, hydro chemical mixer in larger basket, lids with basket strainers, separate in-built 18L fresh water hand wash tank.			
FAN SIZE	P50E: 500mm dia. turbine fan, 4000 rpm. Power consumed 48 kw / 65HP.	FRAME	Galvanised RHS steel construction, cat II linkage.			
NOZZLES	Air shear.	AGITATION	Bypass and pneumatic.			
GEARBOX	Multiplication type through multi-grip, multi-vee belt and pulley, over-run free wheeling hub and oil bath housing.	FILTRATION	Lid strainer and suction line strainer.			
CONTROLS	Two sided electric on/off control valves with control box mounted in cabin. Rotary plate distribution regulators with 15 settings and manual pressure adjustment.	PTO DRIVESHAFT	Quality Bondioli & Pavesi driveshaft with quick release pins & safety cover.			
PRESSURE GAUGE	Protected 100mm glycerine gauge fitted at front of sprayer.	HP REQUIRED	Minimum 65 PTO HP.			
		DIMENSIONS GTM-P50N (LESS HEAD)	L (MM)	W (MM)	H (MM)	KG (DRY)
			1100	1450	1150	220

MODEL DESCRIPTION	CODE	PRICE EX. GST	PRICE INC. GST
600L P50E LINKAGE TURBOMISER: P50E fan (spray head not included)	GTM-P50N	\$24,700	\$27,170
FACTORY OPTIONS	CODE	PRICE EX. GST	PRICE INC. GST
Vineyard head - 4 heads (4 x 4)	GT55-11	\$5,850	\$6,435
Super Cannon head	GT55-1	\$5,500	\$6,050
Manual turntable for Super Cannon	GT55-4	\$1,900	\$2,090
Hydraulic turntable for Super Cannon	GT55-9	\$4,150	\$4,565
Bravo 180S automatic rate controller	GT-24	\$6,900	\$7,590

Note: Not all options will fit all models. Extra charges may apply to fitment of some options. Sprayer depicted with optional sprayhead.

600L Linkage P55DS Turbomiser



Orchards



Vineyards



Greenhouses



AVAILABLE WITH
TURBOMISER
HEAD OPTIONS
SEE PAGE 30



Pictured: P55DS 600L with optional Super Cannon head

MODEL SPECIFICATIONS

PUMP	CD32 centrifugal pump, 140L/min. constructed from toughened nylon. Stainless steel shaft & viton/ceramic seal.	TANK	600L Polytuff impact resistant polyethylene construction, calibrated sight line, non-spill lids, hydro chemical mixer in larger basket, lids with basket strainers, separate in-built 18L fresh water hand wash tank.			
FAN SIZE	P55DS:550mm dia. turbine fan, 3700 rpm. Power consumed 52 kw/70HP.	FRAME	Galvanised RHS steel construction, cat II linkage.			
NOZZLES	Air shear.	AGITATION	Bypass and pneumatic.			
GEARBOX	Multiplication type through multi-grip, multi-vee belt and pulley, over-run free wheeling hub and oil bath fan housing.	FILTRATION	Lid strainer and suction line strainer.			
CONTROLS	Two sided electric on/off control valves with control box mounted in cabin. Rotary plate distribution regulators with 15 settings and manual pressure adjustment.	PTO DRIVESHAFT	Quality Bondioli & Pavesi driveshaft with quick release pins & safety cover.			
PRESSURE GAUGE	Protected 100mm glycerine gauge fitted at front of sprayer.	HP REQUIRED	Minimum 70 PTO HP.			
		DIMENSIONS	L (MM)	W (MM)	H (MM)	KG (DRY)
		GTM-P55DS (LESS HEAD)	1100	1450	1150	250

MODEL DESCRIPTION	CODE	PRICE EX. GST	PRICE INC. GST
600L P55DS LINKAGE TURBOMISER: P55DS fan (spray head not included)	GTM-P55DS	\$26,900	\$29,590
FACTORY OPTIONS	CODE	PRICE EX. GST	PRICE INC. GST
Vineyard head - 4 heads (4 x 5)	GT55D-40	\$7,750	\$8,525
Orchard Cannon head	GT55-13	\$8,700	\$9,570
Super Cannon head	GT55D-1	\$6,600	\$7,260
Hydraulic turntable for Super Cannon	GT55D-9	\$5,000	\$5,500
Bravo 180S automatic rate controller	GT-24	\$6,900	\$7,590

Note: Not all options will fit all models. Extra charges may apply to fitment of some options. Sprayer depicted with optional sprayhead.

600L Linkage Airboom Turbomiser



Strawberries



Row Crop



Pictured: P55DS 600L with 12m Airboom

MODEL SPECIFICATIONS

PUMP	CD32 centrifugal pump 140L/min. constructed from toughened nylon. Stainless steel shaft & Viton/ceramic seal.	TRANSMISSION	Multiplication type through multi-grip, multi-vee belt and pulley, over-run free wheeling hub and oil bath housing.			
BOOM OPTIONS	7m hydraulic fold - 15 fishtail air shear spray outlets. 12m hydraulic fold - 18 fishtail air shear spray outlets.	TANK	600L Polytuff impact resistant polyethylene construction, calibrated sight line, non-spill lids, hydro chemical mixer in larger basket, lids with basket strainers, separate in-built 18L fresh water hand wash tank.			
BOOM ARM	Each arm can be independently folded for turning at row end, 640 mm height adjustment to boom with hydraulic ram, safety break away action.	FRAME	Galvanised RHS steel frame, cat II lift pins with 2 positions.			
FAN SIZE	P55DS: 550mm dia. turbine fan, 3700 rpm. Power consumed 52 kw / 70HP.	AGITATION	Bypass and pneumatic.			
NOZZLES	Low volume fishtail outlets, spacings and angle fully adjustable, ideal for row crops.	FILTRATION	Lid strainer and suction line strainer			
CONTROLS	3 section electric valves with on/off, in cab control box and manual pressure adjustment.	PTO DRIVESHAFT	Quality Bondioli & Pavesi driveshaft with quick release pins & safety cover.			
		HP REQUIRED	Minimum 70 PTO HP.			
		GTMP55N07 (WHEN FOLDED)	L (MM)	W (MM)	H (MM)	KG (DRY)
			5400	1700	1500	400

MODEL DESCRIPTION	CODE	PRICE EX. GST	PRICE INC. GST
600L P55DS LINKAGE AIRBOOM SPRAYER: P55DS fan, 7m hydraulic fold Airboom, fishtail air shear spray outlets	GTMP55N07	\$84,000	\$92,400
600L P55DS LINKAGE AIRBOOM SPRAYER: P55DS fan, 12m hydraulic fold Airboom, fishtail air shear spray outlets	GTMP55N12	\$85,000	\$93,500
FACTORY OPTIONS	CODE	PRICE EX. GST	PRICE INC. GST
Bravo 180S automatic rate controller	GT-24	\$6,900	\$7,590

1500/2000L Trailed P50E Turbomiser



Orchards



Vineyards



AVAILABLE WITH
TURBOMISER
HEAD OPTIONS
SEE PAGE 30



Pictured: 1500L with optional Vineyard head

MODEL SPECIFICATIONS

PUMP	CD32 centrifugal pump, 140L/min, constructed from toughened nylon. Stainless steel shaft & viton/ceramic seal.	FRAME	Galvanised steel chassis, adjustable drawbar with jockey wheel.			
FAN SIZE	P50E: 500mm dia. turbine fan, 4000 rpm. Power consumed 48 kw / 65HP.	AGITATION	Pump bypass plus venturi agitator.			
NOZZLES	Air shear.	FILTRATION	Lid strainer and large capacity suction filter.			
GEARBOX	Multiplication type through multi-grip, multi-vee belt and pulley, over-run free wheeling hub and oil bath housing.	WHEEL EQUIPMENT	Glideflex suspension axle, 2 x 15" tubeless tyres on painted rims (max speed rating 30 km/h).			
CONTROLS	Two sided electric on/off control valves with pressure regulation operated from control box mounted in cabin. Rotary plate distribution regulators with 15 settings. Large 100 mm pressure gauge.	PTO DRIVESHAFT	Quality Bondioli & Pavesi constant velocity driveshaft with quick release pins & safety cover.			
TANK	1500/2000 - Polytuff impact resistant polyethylene construction, calibrated sight line, large non-spill flip top lid, built-in chemical mixer and 40L fresh water tank.	HP REQUIRED	Minimum 65 PTO HP.			
		DIMENSIONS	L (MM)	W (MM)	H (MM)	KG (DRY)
		GTM15P-P50NGL (LESS HEAD)	3860	1540	1530	550
		GTM20P-P50NGL (LESS HEAD)	3970	1540	1530	650
		Length measured with drawbar in shortest position.				

MODEL DESCRIPTION	CODE	PRICE EX. GST	PRICE INC. GST
1500L P50E TRAILED TURBOMISER: P50E fan, Glideflex axle, wide angle PTO shaft (Spray head not included)	GTM15P-P50NGL	\$37,450	\$41,195
2000L P50E TRAILED TURBOMISER: P50E fan, Glideflex axle, wide angle PTO shaft (Spray head not included)	GTM20P-P50NGL	\$37,650	\$41,415
FACTORY OPTIONS	CODE	PRICE EX. GST	PRICE INC. GST
Vineyard head - 4 heads (4x4)	GT55-11	\$5,850	\$6,435
Bravo 180S automatic rate controller	GT-24	\$6,900	\$7,590
Hypro hydraulic drive pump	GT55-22	\$3,000	\$3,300
Flotation tyres - 400/60 x 15.5" with fixed axle (in lieu of standard)	D99-81	\$2,750	\$3,025

When ordering hydraulic drive pumps, tractor hydraulic capacity and system must be written on order. Note: Not all options will fit all models. Extra charges may apply to fitment of some options. Sprayer depicted with optional sprayhead.

2000/3500L Trailed P55DS Turbomiser



Orchards



Vineyards

**AVAILABLE WITH
TURBOMISER
HEAD OPTIONS
SEE PAGE 30**



Pictured: 2000L with optional Turbo Tower

MODEL SPECIFICATIONS

PUMP	CD32 centrifugal pump, 140L/min constructed from toughened nylon. Stainless steel shaft and viton/ceramic seal.	TANK	Polytuff impact resistant polyethylene construction, calibrated sight line, large non-spill flip top lid, built-in Chemical mixer and 40L fresh water hand wash tank.			
FAN SIZE	P55DS: 550mm dia. turbine fan, 3700 rpm. Power consumed 52 kw / 70HP.	AGITATION	Pump bypass plus venturi agitator.			
NOZZLES	Air shear.	FILTRATION	Lid strainer and large capacity suction filter.			
GEARBOX	Multiplication type through multi-grip, multi-vee belt and pulley, over-run free wheeling hub & oil bath housing.	WHEEL EQUIPMENT	Glideflex suspension axle, 2 x 15" tubeless tyres on painted rims (max speed rating 30 km/h).			
CONTROLS	Two sided electric on/off control with pressure regulation operated from control box mounted in cabin. Rotary plate distribution regulators with 15 settings. Large 100mm pressure gauge.	PTO DRIVESHAFT	Quality Bondioli & Pavesi constant velocity driveshaft with quick release pins & safety cover.			
FRAME	Galvanised steel chassis, adjustable drawbar with jockey wheel.	HP REQUIRED	Minimum 70 PTO HP.			
		DIMENSIONS	L (MM)	W (MM)	H (MM)	KG (DRY)
		GTM20P-P55DSSL (LESS HEAD)	3970	1540	1530	650
		GTM35P-P55DSL (LESS HEAD)	4755	1830	1800	800

Length measured with drawbar in shortest position.

MODEL DESCRIPTION	CODE	PRICE EX. GST	PRICE INC. GST
2000L P55DS TRAILED TURBOMISER: P55DS fan, Glideflex axle, wide angle PTO shaft (spray head not included)	GTM20P-P55DSSL	\$38,300	\$42,130
3500L P55DS TRAILED TURBOMISER: P55DS fan, Glideflex axle, wide angle PTO shaft (spray head not included)	GTM35P-P55DSL	\$48,000	\$52,800
FACTORY OPTIONS	CODE	PRICE EX. GST	PRICE INC. GST
Vineyard head - 4 head (4x5)	GT55D-40	\$7,750	\$8,525
Hi Lo Orchard Head (4 outlets)	GT55D-6	\$9,800	\$10,780
Turbo Tower head (6 outlets)	GT55D-7	\$10,500	\$11,550
Orchard Cannon head	GT55-13	\$8,700	\$9,570
Bravo 180S automatic rate controller	GT-24	\$6,900	\$7,590
Hypro hydraulic drive pump	GT55-22	\$3,000	\$3,300
Flotation tyres - 400/ 60 x 15.5" with fixed axle (2000L - in lieu of standard)	D99-81	\$2,750	\$3,025
Flotation tyres - 558 - 400/60 - 22.5 (3500L - in lieu of standard)	D99-79	\$3,500	\$3,850

When ordering hydraulic drive pumps, tractor hydraulic capacity and system must be written on order. Note: Not all options will fit all models. Extra charges may apply to fitment of some options. Sprayer depicted with optional sprayhead.

Turbomiser Heads



Vineyards

VINEYARD HEAD / P45-P55DS

Specifically designed for spraying trellis trained crops targeting the crop from both the top and bottom via multi-directional spray heads i.e. height, tilt, angle, etc.



Orchards

HI LO ORCHARD HEAD / P55DS

Designed for tree crops. The spray tower includes four air shear fishtail outlets providing an air stream top and bottom that converges in the middle for a full canopy coverage.



Greenhouse

SUPER CANNON / P42-P55DS

Designed for single side applications to ground crops and vegetables via multi-directional sprayheads i.e. height, tilt, angle, etc. Optional turntable turns cannon left to right.

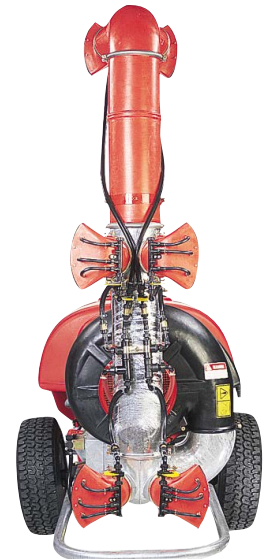

Orchards

TURBO TOWER / P55DS

Suited to the largest Turbomiser fan, the tower utilises six multidirectional spray heads to ensure accurate and complete coverage of tall tree crops.



Orchards

ORCHARD CANNON / P55DS

Suited to the largest Turbomiser fan, the Orchard Cannon utilises double sided orchard heads with two cannons per side for effective coverage in medium to tall tree crops like citrus, almonds and olives.



BH18 / P55DS

The BH18 Turbomiser is a specialised sprayer designed to ensure accurate chemical application on strawberries grown in tunnels on raised tables. Air outlets above and below the tables are designed to create turbulence for effective coverage.

The BH18 can be fitted to 1500L or 2000L trailed sprayers.



Strawberries

Over Row Sprayers

With improved performance and greater flexibility from multiple spray outlets and precise control, Silvan's over row sprayers are the next generation in vineyard spraying.



Silvan Over Row sprayers have been developed to improve spray coverage of vine canopies – and consequently the efficacy of pest and disease control – when spraying multiple rows in just one pass. The best and most efficient spray technology is utilised ensuring an even distribution of spray throughout the entire canopy, minimising drift and off target spraying.

Silvan offers a complete range of multi-row vineyard sprayers with a choice of air assist or air shear depending

on the application. Both are available in 2 & 3 row configurations and all utilise multiple outlet 'wrap' air delivery tubes for greater air turbulence and added flexibility.

The 'wrap' tubes completely surround the canopy, while cane bars protect the lower nozzles from being knocked and damaged. The TGS and standard Turbomiser models utilise a single PTO drive centrifugal fan, while the Turbo

Polytuff UV stabilised, impact resistant tank.

TGS & Turbomiser sprayers have multiple spray outlets for greater flexibility and more targeted spraying.

Hand wash tank.

Galvanised chassis & frame for longer working life.

Tandem suspension axle for a smoother ride.

SCRAM Turbomiser and SCRAM Cross use multiple 320mm hydraulic drive centrifugal fans for reduced power requirements and greater control.

Adjustable outlets together with the fan evenly disperse the spray-laden air for better turbulence within the canopy which reduces water and chemical cost and meets growers needs for crop protection.



Fully galvanised perstructure.

'Wrap' tubes surround canopy for greater turbulence.

TGS & SCRAM X 2 & 3 ROW CONFIGURATIONS



The multi-row TGS spray head uses a turbine fan and curved air tubes to effectively penetrate sprawling vine canopies. Each air diffuser with dual spray nozzles feature swivel adjustment and have an air divider to direct the air evenly to wherever the air diffuser is set. The TGS has the flexibility to be used for concentrate spraying at low application rates or dilute spraying at higher rates.

TURBOMISER & TURBOSCRAM 2 & 3 ROW CONFIGURATIONS

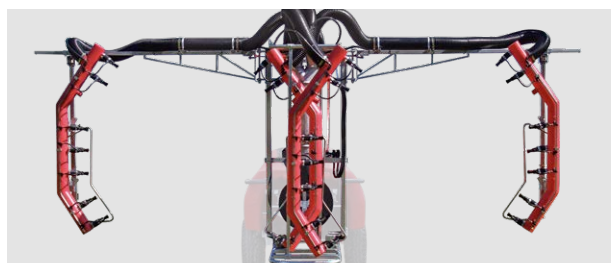

The Turbomiser's centrifugal fan creates a strong current of air which is directed through the air tubes and out the venturi diffusers. With air speeds of up to 170 knots, the liquid is sheared into a narrow range of droplets. This high speed air ensures the spray is directed into the heart of the canopy. The added advantage with our air shear system is it uses up to 75% less water for the same canopy coverage.

TGS



Pictured: 3 Row 3500L TGS

MODEL SPECIFICATIONS

HEAD	Multi row spraying head with air assist diffusers and twin spray nozzles. Each air diffuser features swivel adjustment and air deflector. Poly air tubes shaped to surround canopy. Both arms have independent hydraulic fold with manual width & height adjustment (2 tractor remote sets required).	FRAME	Galvanised steel chassis with adjustable drawbar.			
PUMP	Silvan oil-backed diaphragm type with nitrile diaphragms and corrosion resistant, cast anodised aluminium body with brass heads and manifolds. IDS2001: 182L/min. capacity 5000kPa pressure.	CHEM INDUCTION	Venturi suction probe.			
FAN SIZE	500mm twin impeller turbine fan with twin snorkels, power consumed 48 kw / 64HP.	AGITATION	Pump bypass plus venturi agitator.			
NOZZLES	Twin hollow cone ceramic nozzles per outlet with individual on/off non-drip taps.	PRESSURE GAUGE	0-60 bar glycerine filled gauge fitted to pump.			
GEARBOX	2-speed with neutral position, oil-bath type.	FILTRATION	Lid strainer and suction line strainer.			
CONTROLS	Electric section valves with Bravo 180S automatic rate controller.	WHEEL EQUIPMENT	Tandem suspension with 10 x 15" wheels & tyres (2000L & 3400L) or 11.5 x 15.3" wheels & tyres (3500L & 4000L)			
TANK	Polytuff impact resistant polyethylene construction, calibrated sight line, flip top easy open lid, 50mm camlock bottom fill and 40L fresh water hand wash tank. 205L flush tank on 3400L.	PTO DRIVESHAFT	Quality Bondioli & Pavesi constant velocity (wide angle) driveshaft with quick release pins & safety cover.			
		HP REQUIRED	Minimum 75 PTO HP.			
		DIMENSIONS	L (MM)	W (MM)	H (MM)	KG (DRY)
		DTG23NF5S2	4680	less head folded	1800 2490	3330 980
		TG64NF12	4850	less head folded	1755 2576	3480 1500
		DTG33NF6S2	5640	less head folded	1800 2605	3630 1020
		ETG44NF6S2	5340	less head folded	1935 2490	3160 1820

Length measured with drawbar in shortest position.

MODEL DESCRIPTION		CODE	PRICE EX. GST	PRICE INC. GST
2000L TGS: IDS2001 pump, auto rate controller, 500mm twin turbine fan w/twin snorkel	2 ROW	DTG24NB5S2	\$82,500	\$90,750
	3 ROW	DTG24NB5S3	\$88,500	\$97,350
3400L TGS: IDS2001 pump, auto rate controller, 500mm twin turbine fan w/twin snorkel	2 ROW	TG64NB5I2	\$99,500	\$109,450
	3 ROW	TG64NB5I3	\$105,750	\$116,325
3500L TGS: IDS2001 pump, auto rate controller, 500mm twin turbine fan w/twin snorkel	2 ROW	DTG34NB5S2	\$97,750	\$107,525
	3 ROW	DTG34NB5S3	\$104,250	\$114,675
4000L G2ETGS: IDS2001 pump, auto rate controller, 500mm twin turbine fan w/twin snorkel	2 ROW	ETG44NB6S2	\$104,250	\$114,675
	3 ROW	ETG44NB6S3	\$109,250	\$120,175

FACTORY OPTIONS REFER TO PAGE 40

Turbomiser



Pictured: 3500L Tri-Wrap

MODEL SPECIFICATIONS

HEAD	Two row spraying head: 28 venturi air shear adjustable nozzles with individual metering and on/off taps. Three row spraying head: 42 venturi air shear adjustable nozzles with individual metering and on/off taps. Left & right arms are independent hydraulic folding with adjustable width & centre frame. Boom frame is galvanised.
PUMP	Stainless steel, hydraulic drive centrifugal pump, 350 L/min. Stainless steel shaft and Viton/ceramic seal.
FAN SIZE	550mm turbine fan, 3700 rpm. Power consumed 50 kw / 67HP (2000 & 3500L). 500mm twin impeller turbine fan with twin snorkels, power consumed 48 kw / 64HP (3400 & 4000L)
NOZZLES	Air shear.
GEARBOX	Multiplication type through multi-grip, multi-vee belt and pulley, over-run free wheeling hub and oil bath fan housing.
CONTROLS	Electric section valves with Bravo 180S automatic rate controller. Large 100mm pressure gauge.
TANK	Polytuff impact resistant polyethylene construction, calibrated sight line, flip top easy open lid, 50mm camlock bottom fill and 40L fresh water hand wash tank. 205L flush tank on 3400L.

FRAME	Galvanised steel chassis, adjustable drawbar with jockey wheel.			
AGITATION	Venturi agitator.			
FILTRATION	Lid strainer and large capacity suction filter.			
WHEEL EQUIPMENT	Tandem suspension with 10 x 15" wheels & tyres (2000L & 3400L) or 11.5 x 15.3" wheels & tyres (3500L & 4000L).			
PTO DRIVESHAFT	Quality Bondioli & Pavesi constant velocity (wide angle) driveshaft with quick release pins & safety cover.			
HP REQUIRED	70 PTO HP (2 row), 90 PTO HP (3 row).			
DIMENSIONS	L (MM)	W (MM)	H (MM)	KG (DRY)
GTU28CB5S2	4680	less head folded	1800 2490	3330 990
GTU38CB5S2	5640	less head folded	1935 2605	3630 1100
TU68NB5I2	4850	less head folded	1755 2576	3480 1500
ETU48NB5S2	5340	less head folded	1935 2940	3160 2000

Length measured with drawbar in shortest position.

MODEL DESCRIPTION		CODE	PRICE EX. GST	PRICE INC. GST
2000L P55DSE TRAILED TURBOMISER: Includes sprayheads, P55DSE fan, hydraulic drive stainless steel pump, automatic spray rate controller, wide angle shaft, tandem suspension axle	2 ROW	GTU28CB5S2	\$95,250	\$104,775
	3 ROW	GTU28CB5S3	\$101,500	\$111,650
3400L TRAILED TURBOMISER: Includes sprayheads, twin fan, hydraulic drive stainless steel pump, automatic rate controller, wide angle shaft, tandem suspension axle, 205L flush tank	2 ROW	TU68NB5I2	\$106,500	\$117,150
	3 ROW	TU68NB5I3	\$113,750	\$125,125
3500L P55DSE TRAILED TURBOMISER: Includes sprayheads, P55DSE fan, hydraulic drive stainless steel pump, automatic spray rate controller, wide angle shaft, tandem suspension axle	2 ROW	GTU38CB5S2	\$100,250	\$110,275
	3 ROW	GTU38CB5S3	\$105,500	\$116,050
4000L G2E TRAILED TURBOMISER: Includes sprayheads, twin fan, hydraulic drive stainless steel pump, automatic rate controller, wide angle shaft, tandem suspension axle	2 ROW	ETU48NB6S2	\$107,250	\$117,975
	3 ROW	ETU48NB6S3	\$114,750	\$126,225

FACTORY OPTIONS REFER TO PAGE 40

TurboSCRAM



Pictured: 2000L 2 Row TurboSCRAM

MODEL SPECIFICATIONS

HEAD	Two row spraying head: 28 venturi air shear adjustable nozzles with individual metering and on/off taps.	FRAME	Galvanised steel chassis, linkage hitch fitted with hydraulic power pack.			
	Three row spraying head: 42 venturi air shear adjustable nozzles with individual metering and on/off taps. Left & right arms are independent hydraulic folding with adjustable width & centre frame. Boom frame is galvanised.		AGITATION	Venturi agitator.		
PUMP	Stainless steel, hydraulic drive centrifugal pump, 350 L/min. Stainless steel shaft and Viton/ceramic seal. Driven by tractor remotes.	FILTRATION	Lid strainer and large capacity suction filter.			
FANS	320 mm turbine fan, one per air tube, 3600 rpm. Power consumed 29 kw / 38HP.	WHEEL EQUIPMENT	Tandem suspension with 10 x 15" wheels & tyres (1500L, 2000L & 3400L) or 11.5 x 15.3" wheels & tyres (3500L & 4000L).			
HYDRAULIC CONTROL	Hitch mounted hydraulic power pack with; 40L oil reservoir with cartridge particulate filter, motors fitted with case drain, hydraulic distribution block incorporates anti-cavitation and pressure relief valves, 12V oil cooler.	PTO DRIVESHAFT	Quality Bondioli & Pavesi driveshaft with quick release pins & safety cover.			
		HP REQUIRED	Minimum 60 PTO HP (2 row), 80 PTO HP (3 row).			
NOZZLES	Air shear.	DIMENSIONS	L (MM)	W (MM)	H (MM)	KG (DRY)
CONTROLS	Electric section valves with Bravo 180S automatic rate controller. Large 100mm pressure gauge.	STU18HB5S2	4570	less head folded	1800 2490	3330 890
		STU28HB5S2	4680	less head folded	1800 2490	3330 990
TANK	Polytuff impact resistant polyethylene construction, calibrated sight line, flip top easy open lid, 50mm camlock bottom fill and 40L fresh water hand wash tank. 205L flushtank on 3400L.	STU38HB5S2	5640	less head folded	1935 2605	3630 1100
		STU68HB5S2	4850	less head folded	1755 2576	3480 1500
		SETU48HB6S2	5340	less head folded	1935 2490	3160 1820

Length measured with linkage hitch.

MODEL DESCRIPTION		CODE	PRICE EX. GST	PRICE INC. GST
1500L TRAILED TURBOSCRAM: Includes sprayheads, independent 320mm hydraulic fans, hydraulic drive stainless steel pump, automatic spray rate controller, self contained hydraulic drive system, tandem suspension axle	2 ROW	STU18HB5S2	\$97,750	\$107,525
2000L TRAILED TURBOSCRAM: Includes sprayheads, independent 320mm hydraulic fans, hydraulic drive stainless steel pump, automatic spray rate controller, self contained hydraulic drive system, tandem suspension axle	2 ROW	STU28HB5S2	\$102,500	\$112,750
	3 ROW	STU28HB5S3	\$112,750	\$124,025
3400L TRAILED TURBOSCRAM: Includes sprayheads, independent 320mm hydraulic fans, hydraulic drive stainless steel pump, automatic spray rate controller, self contained hydraulic drive system, tandem suspension axle, 205L flush tank.	2 ROW	STU68HB5S2	\$118,500	\$130,350
	3 ROW	STU68HB5S3	\$128,250	\$141,075
3500L TRAILED TURBOSCRAM: Includes sprayheads, independent 320mm hydraulic fans, hydraulic drive stainless steel pump, automatic spray rate controller, self contained hydraulic drive system, tandem suspension axle	2 ROW	STU38HB5S2	\$106,750	\$117,425
	3 ROW	STU38HB5S3	\$120,000	\$132,000
4000L G2E TRAILED TURBOSCRAM: Includes sprayheads, independent 320mm hydraulic fans, hydraulic drive stainless steel pump, automatic spray rate controller, self contained hydraulic drive system, tandem suspension axle	2 ROW	SETU48HB6S2	\$112,500	\$123,750
	3 ROW	SETU48HB6S3	\$123,750	\$136,125

FACTORY OPTIONS REFER TO PAGE 40

SCRAM X



Pictured: 3500L 3 Row SCRAM X

MODEL SPECIFICATIONS

HEAD	Multi row spraying head with air assist diffusers and twin spray nozzles. Each air diffuser features swivel adjustment and air deflector. Poly air tubes shaped to surround canopy. Both arms have independent hydraulic fold with manual width & height adjustment (2 tractor remote sets required). Boom frame is galvanised.	FRAME	Galvanised steel chassis, linkage hitch fitted with hydraulic power pack.			
PUMP	Multi-stage hydraulic drive pump, multiple impellers made with highly resistant engineering plastic for excellent chemical compatibility. 500+ L/min. Driven by tractor remotes.	AGITATION	Venturi agitator.			
FANS	320 mm turbine fan, one per air tube, 3600 rpm. Power consumed 29 kw / 38HP.	FILTRATION	Lid strainer and large capacity suction filter.			
HYDRAULIC CONTROL	Hitch mounted hydraulic power pack with; 40L oil reservoir with cartridge particulate filter, motors fitted with case drain, hydraulic distribution block incorporates anti-cavitation and pressure relief valves, 12V oil cooler.	WHEEL EQUIPMENT	Tandem suspension with 10 x 15" wheels & tyres (1500L, 2000L & 3400L) or 11.5 x 15.3" wheels & tyres (3500L & 4000L).			
NOZZLES	Twin full cone ceramic nozzles per outlet with individual on/off non-drip taps.	PTO DRIVESHAFT	Quality Bondioli & Pavesi driveshaft with quick release pins & safety cover.			
CONTROLS	Electric section valves with Bravo 180S automatic rate controller. Large 100mm pressure gauge.	HP REQUIRED	Minimum 60 PTO HP (2 row), 80 PTO HP (3 row).			
TANK	Polytuff impact resistant polyethylene construction, calibrated sight line, flip top easy open lid, 50mm camlock bottom fill and 40L fresh water hand wash tank. 205L flushtank on 3400L.	DIMENSIONS	L (MM)	W (MM)	H (MM)	KG (DRY)
		STX18HB5S2	4570	less head folded	1800 2490	3330 890
		STX28HB5S2	4680	less head folded	1800 2490	3330 990
		STX38HB5S2	5640	less head folded	1935 2605	3630 1100
		STX68HB5S2	4850	less head folded	1755 2576	3480 1500
		STX48HB6S2	5340	less head folded	1935 2490	3160 1820

Length measured with linkage hitch.

MODEL DESCRIPTION		CODE	PRICE EX. GST	PRICE INC. GST
1500L TRAILED SCRAM CROSS: Includes sprayheads, independent 320mm hydraulic fans, hydraulic drive stainless steel pump, automatic spray rate controller, self contained hydraulic drive system, tandem suspension axle	2 ROW	STX18HB5S2	\$97,750	\$107,525
2000L TRAILED SCRAM CROSS: Includes sprayheads, independent 320mm hydraulic fans, hydraulic drive stainless steel pump, automatic spray rate controller, self contained hydraulic drive system, tandem suspension axle	2 ROW	STX28HB5S2	\$102,500	\$112,750
	3 ROW	STX28HB5S3	\$112,750	\$124,025
3400L TRAILED SCRAM CROSS: Includes sprayheads, independent 320mm hydraulic fans, hydraulic drive stainless steel pump, automatic spray rate controller, self contained hydraulic drive system, tandem suspension axle, 205L flush tank.	2 ROW	STX68HB5S2	\$118,500	\$130,350
	3 ROW	STX68HB5S3	\$128,250	\$141,075
3500L TRAILED SCRAM CROSS: Includes sprayheads, independent 320mm hydraulic fans, hydraulic drive stainless steel pump, automatic spray rate controller, self contained hydraulic drive system, tandem suspension axle	2 ROW	STX38HB5S2	\$106,750	\$117,425
	3 ROW	STX38HB5S3	\$120,000	\$132,000
4000L G2E TRAILED SCRAM CROSS: Includes sprayheads, independent 320mm hydraulic fans, hydraulic drive stainless steel pump, automatic spray rate controller, self contained hydraulic drive system, tandem suspension axle	2 ROW	STX48HB6S2	\$112,500	\$123,750
	3 ROW	STX48HB6S3	\$123,750	\$136,125

FACTORY OPTIONS REFER TO PAGE 40

Factory Options



Bravo 180S 5+5



Delta 80t



Quick Turning Hitch

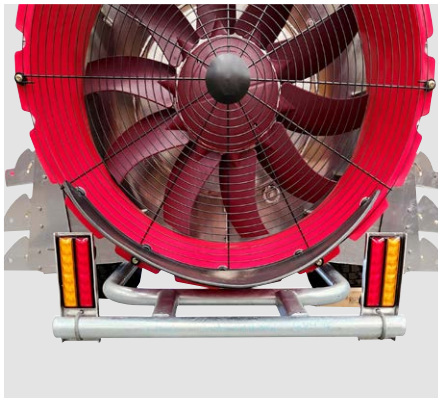

Tail Light Kit



Road Kit

FACTORY OPTIONS	MODEL DESCRIPTION				CODE	PRICE EX. GST	PRICE INC. GST
	TGS	TURBOMISER	TURBOSCRAM	SCRAM X			
IDS2600 pump, 249L/min capacity, 5000kPa pressure					D99-149	\$4,950	\$5,445
Hydraulic pump driven through power pack					D99-185	\$7,700	\$8,470
Hydraulic Height Adjustment - Phased or Independent					TGS-LIFT	POA	POA
Hydraulic Row Width Adjustment - Phased or Independent					D99-186	POA	POA
Bravo 180S spray rate controller with hydraulic controls (in lieu) - Up to 5 sections					J99-180	\$2,600	\$2,860
Bravo 180S spray rate controller with hydraulic controls (in lieu) - 7 sections					D99-196	\$4,900	\$5,390
IBX 100 ISOBUS controller (in lieu - requires compatible in-cab console)					J99-181	\$3,750	\$4,125
Delta 80 Universal Terminal to suit ISOBUS control					4675103	\$14,900	\$16,390
Quick turning hitch					D99-170	\$3,990	\$4,389
Electric Braked Tandem Suspension Axle via Trailer plug - in lieu of std axle.					D99-193	\$5,500	\$6,050
Hydraulic Braked Tandem Suspension Axle - in lieu - requires compatible tractor remotes					D99-194	\$10,900	\$11,990
100L Flush Tank - to suit 1500L, 2000L, 3500L & 4000L					J99-112	\$3,250	\$3,575
Road kit - Brake & Indicator lights with folding Oversize sign.					D99-151	\$2,600	\$2,860
Tail Light Kit - Brake & Indicator lights via trailer plug					D99-195	\$600	\$660

Linkage Sprayers

Silvan linkage sprayers can be equipped to suit herbicide & fungicide applications in a range of crops and are ideal for the management of harmful pests that impact farm productivity.



Silvan is a leader in the design of three point linkage sprayers and the largest Australasian manufacturer of best-in-class linkage sprayers and related machinery. With over fifty years experience, we can advise a sprayer to match your tractor and application, whether for one hectare or one thousand.

Insects and fungi can restrict a plant's growth, whilst weeds compete for water and nutrients reducing pasture production. The Silvan series of three point linkage sprayers are ideal

for the management of harmful pests that impact farm productivity.

Silvan's range of sprayers can be equipped to suit herbicide, insecticide and fungicide applications in a range of crops including orchards, vineyards, vegetables, sugar cane and pasture production. With an extensive range of fully galvanised booms, hose reels & control options, you can customise to your application.

Extensive range of tank sizes from 200 to 1900L.

Polytuff impact resistant tanks with in-built sight line.

Flexible control options.

A range of hose reels and foam marker options.

Range of fully galvanised crop specific manual or hydraulic fold booms from 6 to 18 metres.

Galvanised frame for long working life.





Pictured: 400L Redlink

MODEL SPECIFICATIONS

PUMP	Silvan self-priming oil-backed diaphragm type with nitrile diaphragms and cast anodised aluminium body. BP60/20: 58 L/min. capacity 2000kPa pressure.	AGITATION	Bypass agitation.			
BOOM	Econopak boom: 6m with stainless steel spray lines, non-drip nozzle holders, fully galvanised frame and spring loaded safety break back/forward.	PRESSURE GAUGE	0-25 Bar dual stage glycerine filled gauge.			
NOZZLES	Air induction nozzles with strainer in bayonet fit non-drip nozzle holders at 50cm spacings.	FILTRATION	Lid strainer, suction line strainer and nozzle strainers.			
CONTROLS	3 outlet manual control valve with pressure regulator. Mounted forward for easy access.	HOSE REEL	Fitted with rear-mounted Eco hosereel, 30m of 10mm hose and Spotjet spraygun with adjustable spray nozzle.			
TANK	Slimline 400L Polytuff impact resistant polyethylene construction, moulded litre calibrations and non-spill screw-down lid with single breather.	PTO DRIVESHAFT	Quality driveshaft with quick release pins & safety cover.			
FRAME	Fully galvanised steel, cat I & II linkage.	DIMENSIONS	L (MM)	W (MM)	H (MM)	KG (DRY)
		KBC400 (WITH BOOM)	1200	2067	1330	121

MODEL DESCRIPTION*

MODEL DESCRIPTION*	CODE	PRICE EX. GST	PRICE INC. GST
400L REDLINK LINKAGE SPRAYER: BP60/20 pump, reel, hose & gun, 6m Econopak boom	KBD400	\$3,900	\$4,290

NOTE: BOOM AND HOSE REEL NOT FITTED. \$500 ASSEMBLY CHARGE APPLIES

OPTIONS*

OPTIONS*	CODE	PRICE EX. GST	PRICE INC. GST
14L foam marker (single side)	K99-31	\$1,000	\$1,100
16L foam marker (double side)	K99-39	\$1,500	\$1,650

*Note: Dealer fitment. \$700 charge applies for factory fitment.

Econopak



Pictured: 400L EconoPak

MODEL SPECIFICATIONS

PUMP	Silvan self-priming oil-backed diaphragm type with nitrile diaphragms and cast anodised aluminium body. BP60/20: 58 L/min. capacity 2000kPa pressure.	AGITATION	Bypass agitation.			
BOOM	Econopak boom: 6m with stainless steel spray lines, non-drip nozzle holders, fully galvanised frame and spring loaded safety break back/forward.	PRESSURE GAUGE	0-25 Bar dual stage glycerine filled gauge.			
NOZZLES	Air induction nozzles with strainer in bayonet fit non-drip nozzle holders at 50cm spacings.	FILTRATION	Lid strainer, suction line strainer and nozzle strainers.			
CONTROLS	3 outlet manual control valve with pressure regulator. Mounted forward for easy access.	HOSE REEL	Fitted with rear-mounted Eco hose reel. 30m of 10mm hose and Spotjet spraygun with adjustable spray nozzle.			
TANK	Slimline 300/400/600L Polytuff impact resistant polyethylene construction, moulded litre calibrations and non-spill screw-down lid with single breather.	PTO DRIVESHAFT	Quality driveshaft with quick release pins & safety cover.			
FRAME	Fully galvanised steel, cat I & II linkage.	DIMENSIONS	L (MM)	W (MM)	H (MM)	KG (DRY)
		KBC300 (WITH BOOM)	1105	2067	1070	116
		KBC400 (WITH BOOM)	1105	2067	1310	121
		KBC600 (WITH BOOM)	1200	2067	1400	151

MODEL DESCRIPTION	CODE	PRICE EX. GST	PRICE INC. GST
300L ECONOPAK LINKAGE SPRAYER: BP60/20 pump, reel, hose & gun, 6m Econopak boom, assembled	KBC300	\$4,850	\$5,335
400L ECONOPAK LINKAGE SPRAYER: BP60/20 pump, reel, hose & gun, 6m Econopak boom, assembled	KBC400	\$4,950	\$5,445
600L ECONOPAK LINKAGE SPRAYER: BP60/20 pump, reel, hose & gun, 6m Econopak boom, assembled	KBC600	\$5,500	\$6,050
OPTIONS*	CODE	PRICE EX. GST	PRICE INC. GST
14L foam marker (single side)	K99-31	\$1,000	\$1,100
16L foam marker (double side)	K99-39	\$1,500	\$1,650

*Note: Dealer fitment. \$700 charge applies for factory fitment.

PasturePak



Pictured: 600L PasturePak with 8m boom

MODEL SPECIFICATIONS

PUMP	Silvan self-priming oil-backed diaphragm type with nitrile diaphragms and corrosion resistant, cast anodised aluminium body with raised pump mount. BP60/20: 58 L/min. capacity 2000kPa pressure. BP75/20: 71 L/min. capacity 2000kPa pressure.
BOOM	Field boom: 6m, 8m or 10m with stainless steel spray lines, non-drip nozzle holders, fully galvanised frame, nozzle protection and spring loaded safety break back/forward.
NOZZLES	Air induction nozzles with strainer in bayonet fit non-drip nozzle holders at 50cm spacings.
CONTROLS	3 outlet manual control valve with pressure regulator. Mounted forward for easy access.
TANK	Low profile, 400/600/800L polytuff impact resistant polyethylene construction, external sightline with floating ball and non-spill offset screw-down lid with single breather. 15L fresh water tank with screw down lid and on/off tap. 4L toolbox with polyethylene lid.

FRAME	Fully galvanised steel, cat I & II linkage on 400L, cat II linkage on 600L and 800L.			
AGITATION	Bypass agitation.			
PRESSURE GAUGE	0-25 Bar dual stage glycerine filled gauge.			
FILTRATION	Lid strainer, suction line strainer with stop valve fitted at side of tank to enable easy filter maintenance and nozzle cup strainers.			
HOSE REEL	Fitted with rear-mounted hose reel, including 20m of 12mm I.D. quality pressure hose & JetPro spraygun with convenient trigger action & spray pattern adjustment.			
PTO DRIVESHAFT	Quality driveshaft with quick release pins & safety cover.			
DIMENSIONS				
	L (MM) W (MM) H (MM) KG (DRY)			
KBE400 (WITH BOOM)	1400	2067	1320	150
KBE600 (WITH BOOM)	1500	2067	1400	180
KBE800 (WITH BOOM)	1530	2067	1450	210

MODEL DESCRIPTION	CODE	PRICE EX. GST	PRICE INC. GST
400L PASTUREPAK LINKAGE SPRAYER: BP60/20 pump, reel, hose & gun, 6m Field boom	KBE400	\$6,700	\$7,370
400L PASTUREPAK LINKAGE SPRAYER: BP60/20 pump, reel, hose & gun, 6m Field boom, assembled	KBE400-1	\$7,500	\$8,250
600L PASTUREPAK LINKAGE SPRAYER: BP60/20 pump, reel, hose & gun, 6m Field boom	KBE600	\$7,100	\$7,810
600L PASTUREPAK LINKAGE SPRAYER: BP60/20 pump, reel, hose & gun, 6m Field boom, assembled	KBE600-1	\$7,900	\$8,690
600L PASTUREPAK LINKAGE SPRAYER: BP60/20 pump, reel, hose & gun, 8m Field boom	KBF600	\$7,650	\$8,415
600L PASTUREPAK LINKAGE SPRAYER: BP60/20 pump, reel, hose & gun, 8m Field boom, assembled	KBF600-1	\$8,450	\$9,295
600L PASTUREPAK LINKAGE SPRAYER: BP60/20 pump, reel, hose & gun, 10m Field boom	KBG600	\$8,000	\$8,800
600L PASTUREPAK LINKAGE SPRAYER: BP60/20 pump, reel, hose & gun, 10m Field boom, assembled	KBG600-1	\$8,800	\$9,680
800L PASTUREPAK LINKAGE SPRAYER: BP75/20 pump, reel, hose & gun, 8m Field boom	KBF800	\$8,800	\$9,680
800L PASTUREPAK LINKAGE SPRAYER: BP75/20 pump, reel, hose & gun, 8m Field boom, assembled	KBF800-1	\$9,600	\$10,560
800L PASTUREPAK LINKAGE SPRAYER: BP75/20 pump, reel, hose & gun, 10m Field boom	KBG800	\$9,100	\$10,010
800L PASTUREPAK LINKAGE SPRAYER: BP75/20 pump, reel, hose & gun, 10m Field boom, assembled	KBG800-1	\$9,900	\$10,890
OPTIONS*	CODE	PRICE EX. GST	PRICE INC. GST
14L foam marker (single side)	K99-31	\$1,000	\$1,100
16L foam marker (double side)	K99-39	\$1,500	\$1,650

*Note: Dealer fitment. \$700 charge applies for factory fitment.

EconoMax



Pictured: 1000L EconoMax

MODEL SPECIFICATIONS

PUMP	Silvan self-priming oil-backed diaphragm type with nitrile diaphragms and cast anodised aluminium body. BP130/20: 132 L/min. capacity 2000kPa pressure.	AGITATION	Bypass agitation.			
BOOMS	12m Fieldmaster boom with stainless steel spraylines, non-drip nozzle holders, fully galvanised frame, nozzle protection, spring loaded safety break back/forward and suspension.	PRESSURE GAUGE	0-25 Bar dual stage glycerine filled gauge.			
NOZZLES	Air induction nozzles with strainer in bayonet fit non-drip nozzle holders at 50cm spacings.	FILTRATION	Lid strainer, suction line strainer and nozzle strainers.			
CONTROLS	1 lever, 4 outlet control valves with pressure regulator.	HOSE REEL	Fitted with rear-mounted hose reel, 20m of 12mm hose and JetPro spraygun with trigger action pattern adjustment.			
TANK	Slimline 800/1000L Polytuff impact resistant polyethylene construction, moulded litre calibrations and non-spill screw-down lid with single breather.	PTO DRIVESHAFT	Quality driveshaft with quick release pins & safety cover.			
FRAME	Fully galvanised steel. 800L model : Cat I & II linkage 1000L model : Cat II linkage	DIMENSIONS	L (MM)	W (MM)	H (MM)	KG (DRY)
		KBD800 (WITH BOOM)	1930	2200	2600	250
		KBD1000 (WITH BOOM)	2250	2200	2600	290

MODEL DESCRIPTION	CODE	PRICE EX. GST	PRICE INC. GST
800L ECONOMAX LINKAGE SPRAYER: BP130/20 pump, reel, hose & gun, 12m Fieldmaster boom	KBD800	\$11,500	\$12,650
1000L ECONOMAX LINKAGE SPRAYER: BP130/20 pump, reel, hose & gun, 12m Fieldmaster boom	KBD1000	\$12,800	\$14,080
OPTIONS*	CODE	PRICE EX. GST	PRICE INC. GST
14L foam marker (single side)	K99-31	\$1,000	\$1,100
16L foam marker (double side)	K99-39	\$1,500	\$1,650

*Note: Dealer fitment. \$700 charge applies for factory fitment.



Pictured: 600L SuperPak

MODEL SPECIFICATIONS

PUMP	Silvan self-priming oil-backed diaphragm type with nitrile diaphragms and corrosion resistant, cast anodised aluminium body with raised pump mount. BP60/20: 58 L/min. capacity 2000kPa pressure.
BOOM	Hydraulic boom: 6m independent hydraulic fold boom (requires two sets of tractor remotes) with stainless steel spray lines, non-drip nozzle holders, fully galvanised frame, nozzle protection and spring loaded safety break back.
NOZZLES	Air induction nozzles with strainer in bayonet fit non-drip nozzle holders at 50cm spacings.
CONTROLS	3 outlet manual control valve with pressure regulator. Mounted forward for easy access.
TANK	Low profile, 400/600L polytuff impact resistant polyethylene construction, external sightline with floating ball and non-spill offset screw-down lid with single breather. 15L fresh water tank with screw down lid and on/off tap. 4L toolbox with polyethylene lid.

FRAME	Fully galvanised steel, cat I & II linkage on 400L, cat II linkage on 600L.			
AGITATION	Bypass agitation.			
PRESSURE GAUGE	0-25 Bar dual stage glycerine filled gauge.			
FILTRATION	Lid strainer, suction line strainer with stop valve fitted at side of tank to enable easy filter maintenance and nozzle cup strainers.			
PTO DRIVESHAFT	Quality driveshaft with quick release pins & safety cover.			
DIMENSIONS	L (MM)	W (MM)	H (MM)	KG (DRY)
KBH400 (WITH BOOM)	1300	2067	2200	150
KBH600 (WITH BOOM)	1400	2067	2200	165

MODEL DESCRIPTION	CODE	PRICE EX. GST	PRICE INC. GST
400L SUPERPAK LINKAGE SPRAYER: BP60/20 pump, 6m hydraulic fold boom	KBH400	\$8,500	\$9,350
600L SUPERPAK LINKAGE SPRAYER: BP60/20 pump, 6m hydraulic fold boom	KBH600	\$8,800	\$9,680
OPTIONS*	CODE	PRICE EX. GST	PRICE INC. GST
14L foam marker (single side)	K99-31	\$1,000	\$1,100
16L foam marker (double side)	K99-39	\$1,500	\$1,650
Electric on/off control 3 section	K99-34	\$1,600	\$1,760

*Note: Dealer fitment. \$700 charge applies for factory fitment.

400/600L Super Series



Pictured: 600L with BP60/20 pump

FOR BOOM
& HOSE REEL
SPECIFICATIONS
SEE PAGES 55-58



MODEL SPECIFICATIONS

PUMP	Silvan self-priming oil-backed diaphragm type with nitrile diaphragms and corrosion resistant, cast anodised aluminium body with raised pump mount. BP60/20: 58L/min. capacity 2000kPa pressure BP130/20: 132 L/min. capacity 2000kPa pressure.			
CONTROLS	3 outlet manual control valve with pressure regulator.			
TANK	Low profile, 400 and 600L Polytuff impact resistant polyethylene construction, external sightline with floating ball and non-spill offset screw-down lid with single breather. 15L freshwater tank with screw-down lid and on/off tap. 4L toolbox with polyethylene lid.			
FRAME	Galvanised steel with adjustable cat I & II hitch on 400L and cat II hitch on 600L. Vertical boom channel for positioning the boom at the optimum spray height.			
AGITATION	Bypass agitation.			
PRESSURE GAUGE	0-25 Bar dual stage glycerine filled gauge.			
FILTRATION	Lid strainer, suction line strainer with stop valve fitted at the side of the tank to enable ease of filter maintenance.			
PTO DRIVESHAFT	Quality driveshaft with quick release pins & safety cover.			
DIMENSIONS	L (MM)	W (MM)	H (MM)	KG (DRY)
K04N-60 (LESS BOOM)	930	1020	1320	90
K06N-60 (LESS BOOM)	1025	1150	1400	105

MODEL DESCRIPTION	CODE	PRICE EX. GST	PRICE INC. GST
400L LINKAGE: BP60/20 pump, no boom	K04N-60	\$4,650	\$5,115
400L LINKAGE: BP130/20 pump, no boom	K04N-105	\$4,900	\$5,390
600L LINKAGE: BP60/20 pump, no boom	K06N-60	\$4,950	\$5,445
600L LINKAGE: BP130/20 pump, no boom	K06N-105	\$5,300	\$5,830
FACTORY OPTIONS*	CODE	PRICE EX. GST	PRICE INC. GST
6m Field boom	032-044-6	\$2,000	\$2,200
8m Field boom	032-044-8	\$2,600	\$2,860
10m Field boom	032-044-10	\$2,950	\$3,245
12m Fieldmaster boom with suspension (600L only)	032-40B	\$5,000	\$5,500
6m Hydraulic fold boom	032-19D	\$4,750	\$5,225
8m Devil boom with hydraulic fold	032-25D	\$8,900	\$9,790
8 Jet vine boom	032-G	\$1,500	\$1,650
10 Jet vine boom	032-H	\$1,600	\$1,760
Olive boom (Used with BP130/20 pump only)	032-R	\$2,100	\$2,310
Undervine and mid row boom	032-HERB	\$3,600	\$3,960
Boomless nozzle mounting kit (brass nozzle not included)	K99-10	\$250	\$275
70L flush tank kit to flush the filter, spraylines and nozzles (600L only)	K99-47	\$1,750	\$1,925
14L foam marker (single side)	K99-31	\$1,000	\$1,100
16L foam marker (double side)	K99-39	\$1,500	\$1,650
57L Paddock marker foam marker	K99-43	\$2,000	\$2,200
Economy hosereel, 20m hose (12mm ID) with JetPro spraygun	180E02012CT	\$750	\$825
Reel tuff 12V remote reel with Turbo 400 spray gun (600L only) inc. APS41 pump upgrade	K99-51	\$8,900	\$9,790
Electric on/off control 3 section	K99-34	\$1,600	\$1,760
Electric control 3 section with in cab pressure adjustment	K99-29	\$3,000	\$3,300
Spray Rate automatic rate controller	J99-152	\$6,000	\$6,600
Bravo 180S automatic rate controller	J99-151	\$8,000	\$8,800

Note: Not all options will fit all models. Extra charges may apply to fitment.

800/1100L Super Series



Pictured: 1100L with BP130/20 pump and optional flush tank



Pictured: 800L with BP130/20 pump

MODEL SPECIFICATIONS

PUMP	Silvan self-priming oil-backed diaphragm type with nitrile diaphragms and corrosion resistant, cast anodised aluminium body with raised pump mount. BP75/20: 71L/min. capacity 2000kPa pressure. BP130/20: 132 L/min. capacity 2000kPa pressure.			
CONTROLS	3 outlet manual control valve with pressure regulator.			
TANK	Low profile, 800 and 1100L Polytuff impact resistant polyethylene construction, external sightline with floating ball and non-spill offset screw-down lid with single breather. 15L freshwater tank with screw-down lid and on/off tap. 4L toolbox with polyethylene lid. 50mm Camlock bottom fill (1100L only).			
FRAME	Galvanised steel, with adjustable cat II hitch. Vertical boom channel positions boom at optimum spray height.			
AGITATION	Bypass agitation.			
CHEMICAL INDUCTION	1100L: Venturi suction probe with detachable hose.			
PRESSURE GAUGE	0-25 Bar dual stage glycerine filled gauge.			
FILTRATION	Lid strainer, suction line strainer with stop valve fitted at the side of the tank to enable ease of filter maintenance.			
PTO DRIVESHAFT	Quality driveshaft with quick release pins & safety cover.			
DIMENSIONS	L (MM)	W (MM)	H (MM)	KG (DRY)
K08N-75 (LESS BOOM)	1050	1395	1450	145
K11NH-75 (LESS BOOM)	1200	1395	1750	160

MODEL DESCRIPTION	CODE	PRICE EX. GST	PRICE INC. GST
800L LINKAGE: BP75/20 pump, no boom	K08N-75	\$6,000	\$6,600
800L LINKAGE: BP130/20 pump, no boom	K08N-125	\$6,950	\$7,645
1100L LINKAGE: BP75/20 pump, no boom	K11NH-75	\$9,150	\$10,065
1100L LINKAGE: BP130/20 pump, no boom	K11NH-125	\$9,500	\$10,450
FACTORY OPTIONS*	CODE	PRICE EX. GST	PRICE INC. GST
6m Field boom	032-044-6	\$2,000	\$2,200
8m Field boom	032-044-8	\$2,600	\$2,860
10m Field boom	032-044-10	\$2,950	\$3,245
12m Fieldmaster boom with suspension	032-40B	\$5,000	\$5,500
6m Hydraulic fold boom	032-19D	\$4,750	\$5,225
8m Devil boom with hydraulic fold	032-25D	\$8,900	\$9,790
10m HD Devil boom with hydraulic fold	032-32D	\$11,000	\$12,100
12m HD Devil boom with hydraulic fold**	032-40D	\$12,990	\$14,289
14m HD Devil boom with hydraulic fold**	032-48D	\$13,950	\$15,345
15m HD Devil boom with hydraulic fold**	032-50D	\$14,250	\$15,675
Hydraulic lift, galvanised single hydraulic system - 10, 12, 14 & 15m Devil booms	032-40DL	\$4,500	\$4,950
Hydraulic lift with airbag suspension - 10, 12, 14 & 15m HD Devil booms	032-40DLAB	\$7,900	\$8,690
Parellelogram airbag suspension - 10, 12, 14 and 15m HD Devil Booms (no hydraulic lift)	032-40DLAB-3	\$7,900	\$8,690
8 Jet vine boom (Used with BP60/20 pump only)	032-G	\$1,500	\$1,650
10 Jet vine boom (Used with BP60/20 pump only)	032-H	\$1,600	\$1,760
Olive boom (Use with BP130/20 pump only)	032-R	\$2,100	\$2,310
Undervine and mid row boom	032-HERB	\$3,600	\$3,960
Boomless nozzle mounting kit (brass nozzle not included)	K99-10	\$250	\$275
70L flush tank kit to flush the filter, spraylines and nozzles	K99-47	\$1,750	\$1,925
16L foam marker (double side)	K99-39	\$1,500	\$1,650
57L Paddock marker foam marker	K99-43	\$2,000	\$2,200
Economy hosereel, 20m hose (12mm ID) & JetPro spraygun	180E02012CT	\$750	\$825
Reel tuff 12V remote reel with Turbo 400 spray gun. inc. APS41 pump upgrade	K99-51	\$8,900	\$9,790
Electric on/off control 3 section	K99-34	\$1,600	\$1,760
Electric control 3 section with in cab pressure adjustment	K99-29	\$3,000	\$3,300
Spray Rate automatic rate controller	J99-152	\$6,000	\$6,600
Bravo 180S automatic rate controller	J99-151	\$8,000	\$8,800
IBX 100 ISOBUS controller (in lieu - requires compatible in-cab console)	J99-188	\$11,900	\$13,090
Silmix chemical hopper	K99-21	\$2,750	\$3,025

Note: Not all options will fit all models. Extra charges may apply to fitment.

** If fitting 12, 14 & 15m HD Devil boom to a 800L TPL add \$1,000 for heavier frame

1300/1600/1900L Super Series



Pictured: 1600L Linkage Sprayer with optional 14m HD Devil boom and hydraulic lift with airbag suspension

**FOR BOOM
& HOSE REEL
SPECIFICATIONS
SEE PAGES 55-58**



MODEL SPECIFICATIONS

PUMP	Silvan self-priming oil-backed diaphragm type with nitrile diaphragms and corrosion resistant, cast anodised aluminium body with raised pump mount. BP130/20: 132 L/min. capacity 2000kPa pressure.			
CONTROLS	3 section Silvamatic electric controls with pressure compensating direct acting valves. On/off and pressure adjustment in cab.			
TANK	1300, 1600 and 1900L Polytuff impact resistant polyethylene construction, external sightline with floating ball and non-spill offset screw-down lid with single breather. 10L hand wash tank with screw-down lid and on/off tap. 150L flush tank with screw down lid and external sightline. 50mm Camlock bottom fill.			
FRAME	Galvanised steel, with adjustable cat II & cat III hitch. Vertical boom channel positions boom at optimum spray height.			
AGITATION	Bypass agitation.			
CHEMICAL INDUCTION	30L Silmix chemical hopper mounted on side of tank.			
PRESSURE GAUGE	0-25 Bar dual stage glycerine filled gauge.			
FILTRATION	Lid strainer, suction line strainer with stop valve fitted at the side of the tank to enable ease of filter maintenance.			
PTO DRIVESHAFT	Quality driveshaft with quick release pins & safety cover.			
DIMENSIONS	L (mm)	W (mm)	H (mm)	KG (dry)
K13NH-125E (LESS BOOM)	1480	2300	2140	635
K16NH-125 (LESS BOOM)	1480	2300	2300	650
K19NH-125E (LESS BOOM)	1480	2300	2570	665

MODEL DESCRIPTION	CODE	PRICE EX. GST	PRICE INC. GST
1300L LINKAGE: BP130/20 pump, no boom	K13NH-125E	\$23,400	\$25,740
1600L LINKAGE: BP130/20 pump, no boom	K16NH-125E	\$26,500	\$29,150
1900L LINKAGE: BP130/20 pump, no boom	K19NH-125E	\$29,000	\$31,900
FACTORY OPTIONS*	CODE	PRICE EX. GST	PRICE INC. GST
BP200/20 pump, 195 L/min. capacity, 2000kPa pressure	J99-82	\$1,600	\$1,760
Hydraulic drive centrifugal pump	J99-126	\$3,000	\$3,300
10m HD Devil boom with hydraulic fold	032-32D	\$11,000	\$12,100
12m HD Devil boom with hydraulic fold	032-40D	\$12,990	\$14,289
14m HD Devil boom with hydraulic fold	032-48D	\$13,950	\$15,345
15m HD Devil boom with hydraulic fold	032-50D	\$14,250	\$15,675
Hydraulic lift with airbag suspension - 10, 12, 14 and 15m HD Devil Booms	032-40DLAB	\$7,900	\$8,690
Parellelogram airbag suspension - 10, 12, 14 and 15m HD Devil Booms (no hydraulic lift)	032-40DLAB-3	\$7,900	\$8,690
57L Paddock marker foam marker	K99-43	\$2,000	\$2,200
Spray Rate automatic rate controller	J99-145	\$4,500	\$4,950
Bravo 180S automatic rate controller	J99-146	\$6,000	\$6,600
IBX 100 ISOBUS controller (in lieu - requires compatible in-cab console)	J99-185	\$9,750	\$10,725

Note: Not all options will fit all models. Extra charges may apply to fitment.

SPRAYPRO



Pictured: 1600L Spray Pro with 18m boom

MODEL SPECIFICATIONS

PUMP	Silvan self-priming oil-backed diaphragm type with nitrile diaphragms and corrosion resistant, cast anodised aluminium body with raised pump mount. BP130/20: 132 L/min. capacity 2000kPa pressure.			
BOOM	15 or 18 metre hydraulic lift, fold and tilt with parallel arm boom suspension, nitrogen accumulator and spring-loaded breakbacks. Galvanised boom with stainless steel spraylines. Minimum 3 sets of hydraulic remotes required.			
CONTROLS	3 section Silvamatic electric controls with pressure compensating direct acting valves. On/off and pressure adjustment in cab.			
TANK	1300, 1600 and 1900L Polytuff impact resistant polyethylene construction, external sightline with floating ball and non-spill offset screw-down lid with single breather. 10L hand wash tank with screw-down lid and on/off tap. 150L flush tank with screw down lid and external sightline. 50mm Camlock bottom fill.			
FRAME	Galvanised steel, with adjustable cat II & cat III hitch. Vertical boom channel positions boom at optimum spray height.			
AGITATION	Bypass agitation.			
CHEMICAL INDUCTION	30L Silmix chemical hopper mounted on side of tank.			
PRESSURE GAUGE	0-25 Bar dual stage glycerine filled gauge.			
FILTRATION	Lid strainer, suction line strainer with stop valve fitted at the side of the tank to enable ease of filter maintenance.			
PTO DRIVESHAFT	Quality driveshaft with quick release pins & safety cover.			
DIMENSIONS	L (mm)	W (mm)	H (mm)	KG (dry)
K13NH60T-125E	4100	2300	3410	1320
K16NH60T-125E	4100	2300	3410	1335
K19NH60T-125E	4100	2300	3410	1350

MODEL DESCRIPTION	CODE	PRICE EX. GST	PRICE INC. GST
1300L SPRAY PRO: BP130/20 pump, 15m boom	K13NH50T-125E	\$48,450	\$53,295
1300L SPRAY PRO: BP130/20 pump, 18m boom	K13NH60T-125E	\$49,900	\$54,890
1600L SPRAY PRO: BP130/20 pump, 15m boom	K16NH50T-125E	\$51,500	\$56,650
1600L SPRAY PRO: BP130/20 pump, 18m boom	K16NH60T-125E	\$52,900	\$58,190
1900L SPRAY PRO: BP130/20 pump, 15m boom	K19NH50T-125E	\$54,000	\$59,400
1900L SPRAY PRO: BP130/20 pump, 18m boom	K19NH60T-125E	\$55,500	\$61,050
FACTORY OPTIONS*	CODE	PRICE EX. GST	PRICE INC. GST
BP200/20 pump, 195 L/min. capacity, 2000kPa pressure	J99-82	\$1,600	\$1,760
Hydraulic drive centrifugal pump	J99-126	\$3,000	\$3,300
57L Paddock marker foam marker	K99-43	\$2,000	\$2,200
Spray Rate automatic rate controller	J99-145	\$4,500	\$4,950
Bravo 180S automatic rate controller	J99-146	\$6,000	\$6,600
Bravo 180S automatic rate controller to suit hydraulic control (in lieu)	J99-184	\$8,700	\$9,570
IBX 100 ISOBUS controller (in lieu - requires compatible in-cab console)	J99-185	\$9,750	\$10,725
3 Section electric over hydraulic control	J99-117	\$3,000	\$3,300
5 Section electric over hydraulic control	J99-143	\$4,650	\$5,115

Note: Not all options will fit all models. Extra charges may apply to fitment.

200/300/400L Slimline



Pictured: 200L with BP20/15 pump



Pictured: 300L with BP20/15 pump



Pictured: 400L with BP60/20 pump

**FOR BOOM
& HOSE REEL
SPECIFICATIONS
SEE PAGES 55-58**



MODEL SPECIFICATIONS

PUMP	Silvan self-priming oil-backed diaphragm type with nitrile diaphragms and corrosion resistant, cast anodised aluminium body. BP20/15: 20L/min. capacity 1500kPa pressure. BP60/20: 58L/min. capacity 2000kPa pressure.			
CONTROLS	BP20/15: 2 outlet control valve with pressure regulation. BP60/20: 3 outlet control valve with pressure regulation.			
TANK	Polytuff impact resistant polyethylene construction, moulded litre calibrations and non-spill screw-down lid with single breather.			
FRAME	Fully galvanised steel, cat. I & II linkage.			
AGITATION	Bypass agitation.			
PRESSURE GAUGE	0-25 Bar dual stage glycerine filled gauge.			
FILTRATION	Lid strainer, suction line strainer.			
PTO DRIVESHAFT	Quality driveshaft with quick release pins & safety cover.			
DIMENSIONS	L (MM)	W (MM)	H (MM)	KG (DRY)
K02S-20	920	740	920	60
K03-20	1105	740	1070	70
K04-60	1105	740	1310	75

MODEL DESCRIPTION	CODE	PRICE EX. GST	PRICE INC. GST
200L LINKAGE SPRAYER: BP20/15 pump, no boom	K02S-20	\$3,400	\$3,740
300L LINKAGE SPRAYER: BP20/15 pump, no boom	K03-20	\$3,500	\$3,850
300L LINKAGE SPRAYER: BP60/20 pump, no boom	K03-60	\$3,600	\$3,960
400L LINKAGE SPRAYER: BP60/20 pump, no boom	K04-60	\$3,700	\$4,070

DEALER FITTED OPTIONS	CODE	PRICE EX. GST	PRICE INC. GST
6m Field boom	032-044-6	\$2,000	\$2,200
8m Field boom	032-044-8	\$2,600	\$2,860
8 Jet vine boom (Used with BP60/20 pump only)	032-G	\$1,500	\$1,650
10 Jet vine boom (Used with BP60/20 pump only)	032-H	\$1,600	\$1,760
Undervine & mid row boom	032-HERB	\$3,600	\$3,960
Boomless nozzle mounting kit (brass nozzle not included)	K99-11	\$250	\$275
14L foam marker (single side)	K99-31	\$1,000	\$1,100
16L foam marker (double side)	K99-39	\$1,500	\$1,650
Economy hosereel, 30m hose (10mm ID), PA spray gun & extension lance	180E03010C	\$670	\$737

**Note: Not all options will fit all models.
Extra charges may apply to factory fitment of some options.**

800/1000L Slimline



Pictured: 1000L unit with BP130/20 pump and one lever control valve

MODEL SPECIFICATIONS

PUMP	Silvan self-priming oil-backed diaphragm type with nitrile diaphragms and corrosion resistant, cast anodised aluminium body with raised pump mount (1000L only). BP60/20: 58L/min. capacity 2000kPa pressure. BP130/20: 132 L/min. capacity 2000kPa pressure.			
	CONTROLS			
TANK		Polytuff impact resistant polyethylene construction, moulded litre calibrations and non-spill screw-down lid with single breather.		
FRAME		800L model: Galvanised steel, cat. 1 & II linkage. 1000L model: Galvanised steel with adjustable cat II hitch system. Vertical boom channel for positioning the boom at the optimum spray height.		
AGITATION		Bypass agitation.		
PRESSURE GAUGE		0-25 Bar dual stage glycerine filled gauge.		
FILTRATION		Lid strainer, suction line strainer.		
PTO DRIVESHAFT		Quality driveshaft with quick release pins & safety cover.		
DIMENSIONS	L (MM)	W (MM)	H (MM)	KG (DRY)
K08-60 (LESS BOOM)	1200	1350	1430	120
K10-60 (LESS BOOM)	1500	1670	1630	170

FOR BOOM & HOSE REEL SPECIFICATIONS SEE PAGES 55-58



MODEL DESCRIPTION	CODE	PRICE EX. GST	PRICE INC. GST
800L LINKAGE: BP60/20 pump, no boom	K08-60	\$5,000	\$5,500
800L LINKAGE: BP130/20 pump, no boom	K08-105	\$5,900	\$6,490
1000L LINKAGE: BP60/20 pump, no boom	K10-60	\$6,600	\$7,260
1000L LINKAGE: BP130/20 pump, no boom	K10-105	\$7,350	\$8,085
FACTORY OPTIONS*	CODE	PRICE EX. GST	PRICE INC. GST
6m Field boom	032-044-6	\$2,000	\$2,200
8m Field boom	032-044-8	\$2,600	\$2,860
10m Field boom	032-044-10	\$2,950	\$3,245
12m Fieldmaster boom with suspension (1000L only)	032-40B	\$5,000	\$5,500
6m Hydraulic fold boom	032-19D	\$4,750	\$5,225
8m Devil boom with hydraulic fold	032-25D	\$8,900	\$9,790
10m HD Devil boom with hydraulic fold	032-32D	\$11,000	\$12,100
12m HD Devil boom with hydraulic fold**	032-40D	\$12,990	\$14,289
14m HD Devil boom with hydraulic fold**	032-48D	\$13,950	\$15,345
15m HD Devil boom with hydraulic fold**	032-50D	\$14,250	\$15,675
Hydraulic lift, galvanised single hydraulic system - 10, 12, 14 & 15m devil booms	032-40DL	\$4,500	\$4,950
Hydraulic lift, with airbag suspension - 10, 12, 14 & 15m HD devil booms	032-40DLAB	\$7,900	\$8,690
Parellelogram airbag suspension - 10, 12, 14 and 15m HD Devil Booms (no hydraulic lift)	032-40DLAB-3	\$7,900	\$8,690
8 Jet vine boom	032-G	\$1,500	\$1,650
10 Jet vine boom	032-H	\$1,600	\$1,760
Olive boom (Used with BP130/20 pump only)	032-R	\$2,100	\$2,310
Undervine and mid row boom	032-HERB	\$3,600	\$3,960
70L flush tank kit to flush the filter, spraylines and nozzles (1000L only)	K99-47	\$1,750	\$1,925
16L foam marker (double side)	K99-39	\$1,500	\$1,650
57L Paddock marker foam marker	K99-43	\$2,000	\$2,200
Economy hosereel, 20m hose (12mm ID) & JetPro spraygun	180E02012CT	\$750	\$825
Electric control 3 section with in cab pressure adjustment	K99-29	\$3,000	\$3,300
Spray Rate automatic rate controller	J99-152	\$6,000	\$6,600
Bravo 180S automatic rate controller	J99-151	\$8,000	\$8,800
Silmix chemical hopper	K99-21	\$2,750	\$3,025

Note: Not all options will fit all models. Extra charges may apply to fitment.

** If fitting 12, 14, & 15m Devil boom to a 800L TPL add \$1,000 for heavier frame

Cane Boom



Pictured: 1100L with 6 row spider caneboom

MODEL SPECIFICATIONS

PUMP	Silvan self-priming oil-backed diaphragm type with nitrile diaphragms and corrosion resistant, cast anodised aluminium body. BP60/20: 58 L/min. capacity 2000kPa pressure. BP75/20: 71 L/min. capacity 2000kPa pressure. BP130/20: 132 L/min. capacity 2000kPa pressure.			
BOOM	Cane boom: 4 row or 6 row. Fully galvanised construction, to suit row widths from 1.5 - 1.8m with 500-1300mm shield spray head and brush skirts or 'spider' spray head. Spray heads have heavy duty hinges to withstand drag, parallelogram tracking system.			
NOZZLES	2 x twin nozzle bodies per shielded spray head and air induction nozzles.			
CONTROLS	4 outlet single lever control valve with pressure regulation and gauge.			
TANK	Low profile 600/800/1100L Polytuff impact resistant polyethylene construction, external sightline with floating ball and non-spill offset screw-down lid with single breather. 15L freshwater tank with screw-down lid and on/off tap. 4L toolbox with polyethylene lid. 50mm Camlock bottom fill and venturi chemical suction probe (1100L only).			
FRAME	Fully galvanised steel, cat II adjustable hitch.			
AGITATION	Bypass agitation.			
PRESSURE GAUGE	0-25 Bar dual stage glycerine filled gauge.			
FILTRATION	Lid strainer and suction line strainer with stop valve fitted at side of tank to enable ease of filter maintenance.			
PTO DRIVESHAFT	Quality driveshaft with quick release pins & safety cover.			
DIMENSIONS	L (MM) W (MM) H (MM) KG (DRY)			
K06N-60C	1025	1150	1300	105
K08N-75C	1350	1395	1315	145
K11NH-75C	1350	1395	1610	160

MODEL DESCRIPTION	CODE	PRICE EX. GST	PRICE INC. GST
600L LINKAGE SPRAYER BP60/20 pump, no boom	K06N-60C	\$5,550	\$6,105
600L LINKAGE SPRAYER BP130/20 pump, no boom	K06N-125C	\$5,900	\$6,490
800L LINKAGE SPRAYER BP75/20 pump, no boom	K08N-75C	\$6,600	\$7,260
800L LINKAGE SPRAYER BP130/20 pump, no boom	K08N-125C	\$7,550	\$8,305
1100L LINKAGE SPRAYER BP75/20 pump, no boom	K11NH-75C	\$9,750	\$10,725
1100L LINKAGE SPRAYER BP130/20 pump, no boom	K11NH-125C	\$10,100	\$11,110
BOOM OPTIONS	CODE	PRICE EX. GST	PRICE INC. GST
4 ROW CANE BOOM (SPIDER)	035-4NL	\$11,350	\$12,485
4 ROW CANE BOOM (SHIELDED)	035-4N	\$13,000	\$14,300
6 ROW CANE BOOM (SPIDER) *	035-6NL	\$15,500	\$17,050
6 ROW CANE BOOM (SHIELDED) *	035-6N	\$17,150	\$18,865
Broadacre boom attachment (to suit 4 row - 12 nozzles for 6m coverage)	035-4B	\$1,900	\$2,090
Broadacre boom attachment (to suit 6 row - 20 nozzles for 10m coverage in 3 sections)	035-6B	\$2,900	\$3,190
Broadacre boom attachment (to suit 6 row - 20 nozzles for 10m coverage in 5 sections)	035-6B-5	\$3,900	\$4,290
Hydraulic lift, galvanised single hydraulic system	032-40DL	\$4,500	\$4,950
FACTORY OPTIONS	CODE	PRICE EX. GST	PRICE INC. GST
70L flush tank kit to flush the filter, spraylines and nozzles	K99-47	\$1,750	\$1,925
Electric control 3 section with in cab pressure adjustment	K99-29	\$3,000	\$3,300
Electric control 4 section with in cab pressure adjustment	K99-49	\$4,000	\$4,400
Electric control 5 section with in cab pressure adjustment	K99-50	\$4,150	\$4,565
Spray Rate automatic rate controller	J99-152	\$6,000	\$6,600
Bravo 180S automatic rate controller	J99-151	\$8,000	\$8,800
Silmix chemical hopper	K99-21	\$2,750	\$3,025

Note: Not all options will fit all models.

* 6 row cane boom cannot be fitted to 600L sprayers.

Extra charges may apply to fitment of some options.

** If fitting 6 row cane boom to a 800L TPL add \$1,000 for heavier frame.

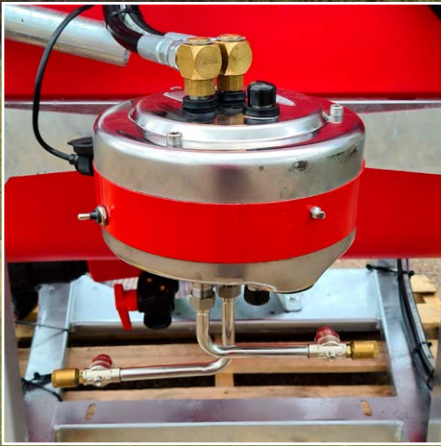

Pictured: 600L Casotti

MODEL SPECIFICATIONS

PUMP	Silvan oil-backed diaphragm type with nitrile diaphragms and corrosion resistant, cast anodised aluminium body. APS71: 71L/min. capacity 5000kPa pressure.	FRAME	Fully galvanised steel, cat II linkage.			
CASOTTI MOTOR	An electric 12 volt motor is connected to the tractor battery which powers the oscillating movement of the nozzle arms. The arms swing 180°. This movement is symmetrical to the tractor's passage.	AGITATION	Bypass agitation.			
CONTROLS	2 outlet brass manual control valve with pressure regulator. Mounted forward for easy access.	SPRAY JETS	3 oscillating high pressure jets (20 bar) Up to 12m spray coverage.			
TANK	Low profile 600/800/1100L Polytuff impact resistant polyethylene construction, external sightline with floating ball and non-spill offset screw-down lid with single breather. 15L freshwater tank with screw-down lid and on/off tap. 4L toolbox with polythylene lid. 50mm Camlock bottom fill (1100L only).	PRESSURE GAUGE	0-60 Bar dual stage glycerine filled gauge.			
		FILTRATION	Lid strainer, suction line strainer with stop valve fitted at side of tank to enable ease of filter maintenance.			
		PTO DRIVESHAFT	Quality driveshaft with quick release pins & safety cover.			
		DIMENSIONS	L (MM)	W (MM)	H (MM)	KG (DRY)
		K06N-71WG (LESS KIT)	1025	1150	1300	105
		K08N-71WG (LESS KIT)	1350	1395	1315	145
		K11N-71WG (LESS KIT)	1350	1395	1610	160

MODEL DESCRIPTION	CODE	PRICE EX.GST	PRICE INC. GST
600L LINKAGE CASOTTI SPRAYER: APS71 pump, Casotti kit	K06N-71WG	\$9,750	\$10,725
800L LINKAGE CASOTTI SPRAYER: APS71 pump, Casotti kit	K08N-71WG	\$10,700	\$11,770
1100L LINKAGE CASOTTI SPRAYER: APS71 pump, Casotti kit	K11N-71WG	\$12,100	\$13,310
CASOTTI KIT: With mounting brackets and hydraulic hoses	K99-36	\$2,900	\$3,190

Booms & Accessories

Silvan's three point linkage and trailed sprayers can be fitted with various booms, hose reels and foam marker options depending on the specific requirements of the application.

Integrated nozzle protection.

Galvanised boom for corrosion resistance and rust protection.

Air induction nozzles for excellent spray coverage and reduced drift.

Stainless steel spraylines for corrosion resistance and longer working life.

Hydraulic folding options delivers in-cab control for increased convenience.

Non drip nozzle holders.

Vineyard & Orchard Booms

UNDER VINE/SHIELDED BOOM SPECIFICATIONS

CONSTRUCTION	Plated RHS frame with spring loaded breakaways to protect the boom if an obstacle is struck.		
SHIELD	Durable poly boom shields with optional brush skirts to minimise spray drift and avoid snagging.		
NOZZLES	Double swivel nozzle holders can be fitted with flat fan or off-centre nozzles.		
DESCRIPTION	CODE	PRICE EX. GST	PRICE INC. GST
UNDER VINE SHIELDED BOOM 480mm long (single swivel and single nozzle)	PF000040	\$650	\$715
UNDER VINE SHIELDED BOOM 600mm long (double swivel and single nozzle)	PF000039	\$650	\$715
UNDER VINE AND MID ROW BOOM Includes brush skirts (2.5-4.5m*)	032-HERB	\$3,600	\$3,960
SHIELDED MID ROW BOOM Includes brush skirts (2m)	032-Q	\$1,750	\$1,925
BRUSH SKIRT	GP00600010	\$120	\$132

Note: Not all options will fit all models.
Extra charges may apply to fitment of some options.
* Total spray width subject to spray head adjustment, nozzle angle and nozzle type.

Under vine shielded boom



Under vine and mid row boom

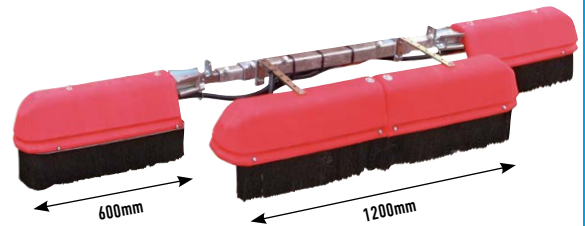

Shielded mid row boom



ADJUSTABLE VINE BOOM SPECIFICATIONS

SIZE	8 jet and 10 jet.		
CONSTRUCTION	Plated RHS frame with stainless steel spraylines.		
BOOM ADJUSTMENT	Two telescopic arms for width adjustment with pivoting spraybars to adjust spray angle.		
NOZZLES	High pressure adjustable brass nozzle holder with ceramic tips. Nozzles can be adjusted from cone to straight jet. Nozzle body angle also variable.		
CAPACITY	Recommended 60L/min pump for 8 jet and 90L/min pump for 10 jet vine boom.		

DESCRIPTION	CODE	PRICE EX. GST	PRICE INC. GST
ADJUSTABLE VINE BOOM 8 Jet vine boom	032-G	\$1,500	\$1,650
10 Jet vine boom	032-H	\$1,600	\$1,760

Note: Not all options will fit all models.
Extra charges may apply to fitment of some options.

10 Jet Vine boom

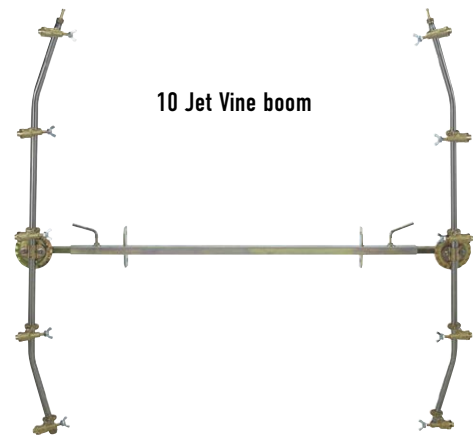

OLIVE BOOM SPECIFICATIONS

SIZE	9 jet.		
CONSTRUCTION	Fully galvanised all steel construction with stainless steel spraylines.		
BOOM ADJUSTMENT	Telescopic arm for width adjustment together with pivoting spraybars to adjust spray angle.		
NOZZLES	High pressure adjustable brass nozzle holder with ceramic tips. Nozzles can be adjusted from cone to straight jet. Nozzle body angle also variable.		
CAPACITY	Recommended 120L/min pump.		

DESCRIPTION	CODE	PRICE EX. GST	PRICE INC. GST
OLIVE BOOM	032-R	\$2,100	\$2,310

Note: Not all options will fit all models.
Extra charges may apply to fitment of some options.

Olive boom



Field & Cane Booms



12m Fieldmaster boom



6m Field boom



6m Econopak boom

MANUAL FOLD BOOM SPECIFICATIONS	
SIZE	6, 8, 10 and 12m.
CONSTRUCTION	Fully galvanised all steel construction.
BOOM ADJUSTMENT	Booms fold horizontally at rear of sprayer (12m cross fold). Break back device that protects boom if obstruction is hit. Spring suspension on Fieldmaster.
SPRAYLINES	Stainless steel spraylines with 50cm nozzle spacings and nozzle protection (Field & Fieldmaster booms only)
NOZZLES	Non-drip nozzle holders, supplied with air induction nozzles and nozzle strainers.

DESCRIPTION	CODE	PRICE EX. GST	PRICE INC. GST
6M ECONOPAK BOOM	ZZ032-19A	\$1,250	\$1,375
6M FIELD BOOM	032-044-6	\$2,000	\$2,200
8M FIELD BOOM	032-044-8	\$2,600	\$2,860
10M FIELD BOOM	032-044-10	\$2,950	\$3,245
12M FIELDMASTER BOOM	032-40B	\$5,000	\$5,500

Note: Not all options will fit all models. Extra charges may apply to fitment of some options.

035-CS
'Spider'
cane spray head



4 Row Shielded Cane boom



CANE BOOM SPECIFICATIONS	
SIZE	4 row or 6 row to suit row widths from 1.5 to 1.8m
CONSTRUCTION	Robust fully galvanised construction.
SPRAYHEADS	Fitted with heavy duty hinges to withstand drag and parallelogram tracking system. Shielded spray head available standard as 900mm with fitted with brush skirts. 500-1300mm width sprayhead options are available.
BOOM FOLDING	Hydraulic twin folding ram mechanism (folding requires one set of tractor remotes) with automatic cable fold mechanism for spray heads.
SPRAYLINES	Stainless steel spraylines.
NOZZLES	Two twin swivel nozzle bodies per spray head with air induction nozzles and nozzle strainers.

MODEL DESCRIPTION	CODE	PRICE EX. GST	PRICE INC. GST
4 ROW SPIDER CANE BOOM WITH HYDRAULIC FOLD	035-4NL	\$11,350	\$12,485
4 ROW SHIELDED CANE BOOM WITH HYDRAULIC FOLD	035-4N	\$13,000	\$14,300
6 ROW SPIDER CANE BOOM WITH HYDRAULIC FOLD	035-6NL	\$15,500	\$17,050
6 ROW SHIELDED CANE BOOM WITH HYDRAULIC FOLD	035-6N	\$17,150	\$18,865
FACTORY OPTIONS	CODE	PRICE EX. GST	PRICE INC. GST
Broadacre boom attachment (to suit 4 row - 12 nozzles for 6m coverage)	035-4B	\$1,900	\$2,090
Broadacre boom attachment (to suit 6 row - 20 nozzles for 10m coverage in 3 sections)	035-6B	\$2,900	\$3,190
Broadacre boom attachment (to suit 6 row - 20 nozzles for 10m coverage in 5 sections)	035-6B-5	\$3,900	\$4,290
Hydraulic lift	032-40DL	\$4,500	\$4,950
ACCESSORIES	CODE	PRICE EX. GST	PRICE INC. GST
Spider cane spray head (each)	035-CS	\$450	\$495
Cane Boom Shield Assembly (pair)	K99-40	\$1,950	\$2,145
Cane Boom Parallelogram Arm - Inner (pair)	K99-41	\$2,100	\$2,310
Cane Boom Parallelogram Arm - Outer (pair)	K99-42	\$2,100	\$2,310

Note: Not all options will fit all models. Extra charges may apply to fitment of some options.

Hydraulic Booms



6m Hydraulic boom

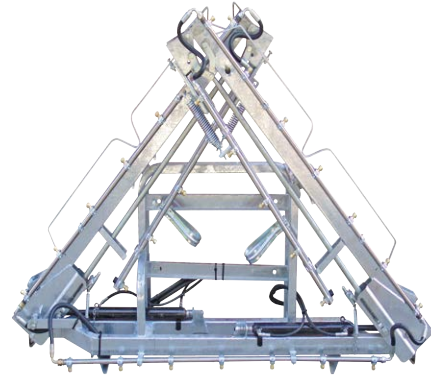

8m Devil boom

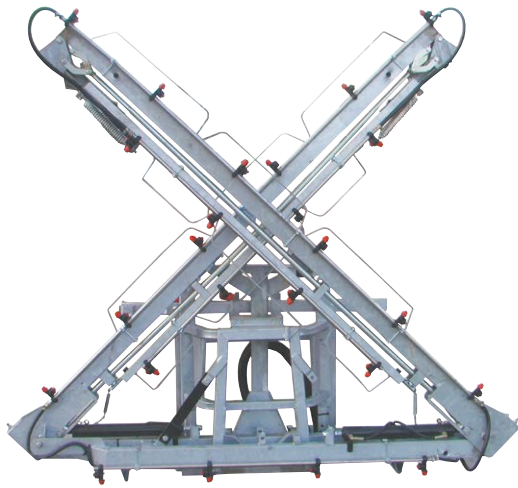

10m & 12m HD Devil boom

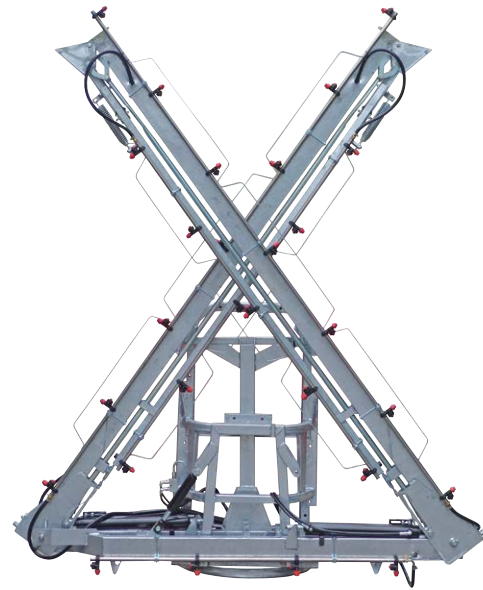

14m & 15m HD Devil boom

DEVIL BOOM SPECIFICATIONS

SIZE	6, 8, 10, 12, 14 and 15m
CONSTRUCTION	Fully galvanised high-tensile steel truss-section frame.
SPRAYLINES	Stainless steel spraylines with 50cm nozzle spacings and air induction nozzles.

BOOM ADJUSTMENT

Two independent hydraulic rams. (Folding requires 2 sets of tractor remotes). Spring loaded breakback of outer arm.

Hydraulic boom tilt adjustment available on HD Devil booms in lieu of self levelling (requires an extra set of tractor remotes).

MODEL DESCRIPTION	WEIGHT	CODE	PRICE EX. GST	PRICE INC. GST
6M HYDRAULIC FOLD BOOM	60kg	032-19D	\$4,750	\$5,225
6M HYDRAULIC FOLD SHIELDED BOOM	90kg	032-19D-Q	\$10,000	\$11,000
8M DEVIL BOOM WITH HYDRAULIC FOLD	120kg	032-25D	\$8,900	\$9,790
10M HD DEVIL BOOM WITH HYDRAULIC FOLD & SELF LEVELLING	200kg	032-32D	\$11,000	\$12,100
12M HD DEVIL BOOM WITH HYDRAULIC FOLD & SELF LEVELLING	215kg	032-40D	\$12,990	\$14,289
14M HD DEVIL BOOM WITH HYDRAULIC FOLD & SELF LEVELLING	235kg	032-48D	\$13,950	\$15,345
15M HD DEVIL BOOM WITH HYDRAULIC FOLD & SELF LEVELLING	240kg	032-50D	\$14,250	\$15,675
FACTORY OPTIONS		CODE	PRICE EX. GST	PRICE INC. GST
Hydraulic lift, galvanised single hydraulic system for 10, 12, 14 & 15m Devil booms		032-40DL	\$4,500	\$4,950
Hydraulic lift, airbag suspension system for HD Devil booms		032-40DLAB	\$7,900	\$8,690
Parallelogram/airbag suspension for HD Devil booms (excludes hydraulic lift)		032-40DLAB-3	\$7,900	\$8,690
Triple nozzles (excludes extra nozzles)		J99-187	\$60 ea	\$66 ea

Note: Extra charges may apply to fitment of some options.

Accessories



Pictured: 30L Silmix on Frame



Pictured: 57L Paddock foam marker

FREE STANDING SILMIX

TANK	30L polyethylene tank with 455mm hinged lid.			
FUNCTION	Uses external water supply to activate venturi inductor at the base of the unit to transfer chemicals from hopper to sprayer tank. The same water supply operates the wash bar and drum rinse nozzle in the hopper. Transfer system requires minimum 2 Bar water pressure to operate (max 8 bar).			
CONTROLS	3 on/off taps to control: 1. Powder washer bar inside hopper. 2. Drum rinse nozzle. 3. Chemical transfer venturi. Also has ball valve at base of unit to isolate the tank from the induction venturi.			
DIMENSIONS	L (MM)	W (MM)	H (MM)	KG (DRY)
	640	640	830	15

PADDOCK FOAM MARKER

TANK	Polyethylene tank with moulded litre calibration indicators.		
COMPRESSOR	Fully sealed, dust free compressor and electrics box with air breather.		
CONTROLS	Double sided operation with electric cab control. Needle valve for foam output adjustment.		
DROPPERS	2 foam droppers.		
HOSE	16L: 16m of delivery hose. 57L: 36m of delivery hose.		

MODEL DESCRIPTION	CODE	PRICE EX. GST	PRICE INC. GST
16L FOAM MARKER	042D-16S	\$1,200	\$1,320
57L PADDOCK FOAM MARKER	042D-57	\$1,600	\$1,760

MODEL DESCRIPTION	CODE	PRICE EX. GST	PRICE INC. GST
SILVAN 30L SILMIX	5033301	\$1,900	\$2,090
SILVAN 30L SILMIX ON FRAME	042J-06ST	\$3,150	\$3,465

Note: Replacement foam marker kits only. If required with mounting brackets for fitment to a Silvan sprayer then refer to the relevant product page for product code.



Pictured: Reel tuff 12V remote reel



Pictured: Economy reel kit with 30m of 10mm ag hose & PA spray gun

FACTORY OPTIONS

	CODE	PRICE EX. GST	PRICE INC. GST
Reel tuff 12V remote reel with Turbo 400 spray gun. inc. APS41 pump upgrade (including bracket for super series linkage units)	K99-51	\$8,900	\$9,790
Economy reel, 20m hose (12mm ID) & JetPro spraygun	180E02012CT	\$750	\$825
Economy reel, 30m x 10mm ag hose & PA spray gun with stainless steel extension	180E03010C	\$670	\$737

Note: Not all options will fit all models. Extra charges may apply to fitment of some options.

Trailed & Sled Mount Sprayers

Silvan offer sprayers for specific applications which can be customised with an extensive range of options. Designed for use in vineyards, pasture, turf and vegetable production.



2500/3000L Paddock Pak



Pictured: 3000L Paddock Pak with optional 57L foam marker, Silmix chemical hopper and mudguards

MODEL SPECIFICATIONS

PUMP	Silvan self-priming oil backed diaphragm pump. BP130/20: 132 L/min. capacity 2000kPa pressure.	FLUSH TANK	100 Litre.
BOOM	15 or 18 metre hydraulic lift, fold and tilt with parallel arm boom suspension, nitrogen accumulator and spring-loaded breakbacks. Galvanised boom with stainless steel spraylines. Minimum 3 sets of hydraulic remotes required.	FRAME	Galvanised RHS steel construction with adjustable drawbar and operator platform.
CONTROLS	3 section Silvamatic electric controls with pressure compensating direct acting valves. In cab on/off & pressure adjustment with pressure gauge.	AGITATION	2 stage agitation. Bypass action and Venturi agitation.
TANK	Polytuff impact resistant polyethylene construction with calibrated sight line & non-spill screw down lid.	FILTRATION	Lid strainer, suction line filter.
		WHEEL EQUIPMENT	2m track axle with 14.9 x 24" lug tyre.
		BOTTOM FILL	Bottom fill valve with camlock coupling.
		DIMENSIONS	L (MM) W (MM) H (MM) KG (DRY)
		2A18H3FA	5400 2500 2870 1400

MODEL DESCRIPTION	CODE	PRICE EX. GST	PRICE INC. GST
2500L PADDOCK PAK: BP130/20 pump, 3 section electric valve controls, 15 metre boom	2A15H3FA	\$49,900	\$54,890
2500L PADDOCK PAK: BP130/20 pump, 3 section electric valve controls, 18 metre boom	2A18H3FA	\$51,000	\$56,100
3000L PADDOCK PAK: BP130/20 pump, 3 section electric valve controls, 15 metre boom	3A15H3FA	\$52,500	\$57,750
3000L PADDOCK PAK: BP130/20 pump, 3 section electric valve controls, 18 metre boom	3A18H3FA	\$53,600	\$58,960
FACTORY OPTIONS	CODE	PRICE EX. GST	PRICE INC. GST
BP200/20 pump, 195 L/min. capacity, 2000kPa pressure	J99-82	\$1,600	\$1,760
Hydraulic drive for BP130/20 PTO Pump	J99-140	\$5,000	\$5,500
Hydraulic drive centrifugal pump	J99-126	\$3,000	\$3,300
5 section Silvamatic electric controls (in lieu)	J99-13	\$1,500	\$1,650
Spray Rate automatic rate controller (in lieu)	J99-145	\$4,500	\$4,950
Bravo 180S automatic rate controller (in lieu)	J99-146	\$6,000	\$6,600
Bravo 180S automatic rate controller to suit hydraulic control (in lieu)	J99-184	\$8,700	\$9,570
IBX 100 ISOBUS controller (in lieu - requires compatible in-cab console)	J99-185	\$9,750	\$10,725
Mudguards (to suit 14.9 x 24" wheels)	J99-162	\$3,700	\$4,070
Adjustable track axle (minimum 1500mm) with 11.2 x 44" Lug tyres (2500L only)	J99-84	\$9,000	\$9,900
57L Paddock Foam Marker	K99-43	\$2,000	\$2,200
Venturi suction probe	J99-60	\$650	\$715
Silmix Chemical Hopper	K99-21	\$2,750	\$3,025
3 Section electric over hydraulic control	J99-117	\$3,000	\$3,300
5 Section electric over hydraulic control	J99-143	\$4,650	\$5,115

Note: Not all options will fit all models. Extra charges may apply to fitment of some options.

2500/3000L Pasture Sprayer



Pictured: 2500L Pasture sprayer with optional 15m Devil boom, mudguards and hydraulic lift

MODEL SPECIFICATIONS

PUMP	Silvan self-priming oil-backed diaphragm type with nitrile diaphragms & corrosion resistant cast anodised aluminium body. BP130/20: 132 L/min. capacity 2000kPa pressure.
TANK	Polytuff impact resistant polyethylene construction with calibrated sight line & non-spill screw down lid.
CHASSIS	Galvanised RHS steel construction with adjustable drawbar and operator platform.
AXLE	2m track axle with 14.9 x 24" lug tyre (450mm clearance).
BOTTOM FILL	Bottom fill with 2" camlock coupling.

FILTER	Lid strainer, suction line filter.			
CONTROLS	3 section Silvamatic electric controls with pressure compensating direct acting valves. In cab on/off & pressure adjustment with pressure gauge.			
FLUSH TANK	100L			
FRESH WATER	Hand wash tap fitted to flush tank.			
DIMENSIONS	L (MM)	W (MM)	H (MM)	KG (DRY)
2A0000FA	4400	2400	2500	800
3A0000FA	4400	2400	2500	850

MODEL DESCRIPTION	CODE	PRICE EX. GST	PRICE INC. GST
2500L PASTURE SPRAYER: BP130/20 pump, 3 section electric valve controls	2A0000FA	\$29,250	\$32,175
3000L PASTURE SPRAYER: BP130/20 pump, 3 section electric valve controls	3A0000FA	\$31,850	\$35,035
FACTORY OPTIONS	CODE	PRICE EX. GST	PRICE INC. GST
BP200/20 pump, 195 L/min. capacity, 2000kPa pressure	J99-82	\$1,600	\$1,760
Hydraulic drive for BP130/20 PTO Pump	J99-140	\$5,000	\$5,500
Hydraulic drive centrifugal pump	J99-126	\$3,000	\$3,300
5 section Silvamatic electric controls (in lieu)	J99-13	\$1,500	\$1,650
Spray Rate automatic rate controller (in lieu)	J99-145	\$4,500	\$4,950
Bravo 180S automatic rate controller (in lieu)	J99-146	\$6,000	\$6,600
Bravo 180S automatic rate controller to suit hydraulic control (in lieu)	J99-184	\$8,700	\$9,570
IBX 100 ISOBUS controller (in lieu - requires compatible in-cab console)	J99-185	\$9,750	\$10,725
Mudguards (to suit 14.9 x 24" wheels)	J99-162	\$3,700	\$4,070
Adjustable track axle (minimum 1500mm) with 11.2 x 44" Lug tyres (2500L only)	J99-84	\$9,000	\$9,900
Simplicity tandem axle with 15" Lug tyres	D99-76	\$1,300	\$1,430
2m track axle with 31 x 13.5" Turf tyre	J99-85	\$1,000	\$1,100
10m HD Devil boom with self levelling	032-32D	\$11,000	\$12,100
12m HD Devil boom with self levelling	032-40D	\$12,990	\$14,289
14m HD Devil boom with self levelling*	032-48D	\$13,950	\$15,345
15m HD Devil boom with self levelling*	032-50D	\$14,250	\$15,675
Hydraulic lift, galvanised single hydraulic system - 10, 12, 14 and 15 HD Devil booms	032-40DL	\$4,500	\$4,950
Airbag suspension & hydraulic lift (to suit HD Devil boom)	032-40DLAB	\$7,900	\$8,690
Parallelogram/airbag suspension (to suit HD Devil boom) - no hydraulic lift	032-40DLAB-3	\$7,900	\$8,690
57L Paddock Foam Marker	K99-43	\$2,000	\$2,200
Venturi suction probe	J99-60	\$650	\$715
Silmix Chemical Hopper	K99-21	\$2,750	\$3,025
3 Section electric over hydraulic control	J99-117	\$3,000	\$3,300
5 Section electric over hydraulic control	J99-143	\$4,650	\$5,115

Note: Not all options will fit all models. Extra charges may apply to fitment of some options.

*When fitting 14 & 15m HD devil boom 032-40DLAB or 032-40DLAB-3 must be added.

1000/2000L Paddockmaster



Pictured: 2000L Paddockmaster sprayer with hydraulic drive pump, 12m Fieldmaster boom, 24" wheels and mudguards

MODEL SPECIFICATIONS

PUMP	Silvan self-priming oil-backed diaphragm type with nitrile diaphragms and corrosion resistant, cast anodised aluminium body. BP60/20: 58L/min capacity 2000kPa pressure. BP130/20: 132 L/min. capacity 2000kPa pressure.	AGITATION	Bypass action.
CONTROLS	3 section Silvamatic electric controls with pressure compensating direct acting valves. In cab on/off & pressure adjustment with pressure gauge.	PRESSURE GAUGE	0-25 Bar dual stage glycerine filled gauge mounted on adjustable arm.
TANK	Polytuff impact resistant polyethylene construction, calibrated sight line, non-spill screw-down lid with dual breathers.	FILTRATION	Lid strainer and suction line strainer
FRAME	Galvanised RHS steel construction, jockey wheel & height adjustable tow hitch.	WHEELS	60mm straight single axle fitted with 15" tubeless tyres on painted rims (max speed rating 30km/h).
		PTO	Quality driveshaft with quick release pins & safety cover.
		DIMENSIONS	L (MM) W (MM) H (MM) KG (DRY)
		J10-S60	2600 1400 1620 290
		J20-S105	3500 1550 2100 440

MODEL DESCRIPTION	CODE	PRICE EX. GST	PRICE INC. GST
1000L PASTURE SPRAYER: BP60/20 pump, electric controls	J10-S60	\$14,850	\$16,335
2000L PASTURE SPRAYER: BP130/20 pump, electric controls	J20-S105	\$18,700	\$20,570
FACTORY OPTIONS	CODE	PRICE EX. GST	PRICE INC. GST
6m Field boom	032-044-6	\$2,000	\$2,200
6m Hydraulic fold boom	032-19D	\$4,750	\$5,225
8m Field boom	032-044-8	\$2,600	\$2,860
8m Devil boom with hydraulic fold	032-25D	\$8,900	\$9,790
10m Field boom	032-044-10	\$2,950	\$3,245
12m Fieldmaster boom with suspension	032-40B	\$5,000	\$5,500
Undervine and mid row boom	032-HERB	\$3,600	\$3,960
16L foam marker (double sided)	K99-39	\$1,500	\$1,650
Economy hosereel, 20m hose (12mm ID) and JetPro spraygun	180E02012CT	\$750	\$825
Spray Rate automatic rate controller	J99-145	\$4,500	\$4,950
Bravo 180S automatic rate controller	J99-146	\$6,000	\$6,600
Hydraulic drive centrifugal pump	J99-126	\$3,000	\$3,300
2m track axle with 14.9 x 24" lug tyres (in lieu - 2000L only)	J99-86	\$4,500	\$4,950
Mudguards (to suit 14.9 x 24" wheels)	J99-162	\$3,700	\$4,070

Note: Not all options will fit all models. Extra charges may apply to fitment of some options.

1000/2000L Turf Sprayer



Pictured: 2000L Turf Sprayer with optional 8m Field boom, Silmix, Bravo 180S rate controller and foam marker

MODEL SPECIFICATIONS

PUMP	Silvan self-priming oil-backed diaphragm type with nitrile diaphragms and corrosion resistant, cast anodised aluminium body. BP130/20: 132 L/min. capacity 2000kPa pressure.	PRESSURE GAUGE	0-25 Bar dual stage glycerine filled gauge.		
CONTROLS	3 section Silvamic electric controls with pressure compensating direct acting valves. In cab on/off & pressure adjustment with pressure gauge.	FILTRATION	Suction line filter & lid strainer.		
TANK	1000/2000L polytuff impact resistant polyethylene construction. Calibrated sight line. Non-spill screw-down lid with breather.	WHEELS	Tubeless 29 x 13.5 - 15" turf tyres with painted rims on 1000L unit. Tubeless 31 x 13.5 - 15" turf tyres with painted rims on 2000L unit.		
FRAME	Galvanised RHS steel construction with jockey wheel.	HOSEREEL	30m of 19mm PVC hose and fish mouth fertiliser nozzle.		
AGITATION	Bypass action and venturi agitator.	DIMENSIONS	L (MM)	W (MM)	H (MM)
		PR10-01	3400	1870	1825
		PR20-2	3500	1550	2100
					KG (DRY)
					275
					400

MODEL DESCRIPTION	CODE	PRICE EX. GST	PRICE INC. GST
1000L TURF SPRAYER: BP130/20 diaphragm pump, electric controls and Pitarm hosereel with fish mouth nozzle	PR10-01	\$21,500	\$23,650
2000L TURF SPRAYER: BP130/20 diaphragm pump, electric controls and Pitarm hosereel with fish mouth nozzle	PR20-2	\$24,900	\$27,390
FACTORY OPTIONS	CODE	PRICE EX. GST	PRICE INC. GST
6m Field boom	032-044-6	\$2,000	\$2,200
6m Hydraulic fold boom	032-19D	\$4,750	\$5,225
8m Field boom	032-044-8	\$2,600	\$2,860
8m Devil boom with hydraulic fold	032-25D	\$8,900	\$9,790
10m Field boom	032-014-10	\$2,950	\$3,245
10m Devil boom with hydraulic fold (2000L only)	032-32D	\$11,000	\$12,100
12m Devil boom with hydraulic fold (2000L only)	032-40D	\$12,990	\$14,289
10 and 12m Devil boom hydraulic lift	032-40DL	\$4,500	\$4,950
16L foam marker (double sided)	K99-39	\$1,500	\$1,650
Spray Rate automatic rate controller	J99-145	\$4,500	\$4,950
Bravo 180S automatic rate controller	J99-146	\$6,000	\$6,600
BP130/20, 121L/min capacity, 2000kPa driven by 5.5HP Honda	CUSH-14	\$3,000	\$3,300

Note: Not all options will fit all models. Extra charges may apply to fitment of some options.

400L Tray Mount Turf Sprayer



Pictured: 400L tray demountable sled sprayer with optional hydraulic 6m Devil boom and foam marker. (Vehicle shown for illustrative purposes only)
Suited to 1.2m x 1.4m tray

MODEL SPECIFICATIONS

PUMP	Silvan self-priming oil-backed diaphragm type with nitrile diaphragms and corrosion resistant, cast anodised aluminium body. BP60/20: 58 L/min capacity, 2000kPa pressure, direct driven by 5.5HP Honda with 6.1 reduction gear box.	FRAME	Fully galvanised RHS steel sled frame for fitment into tray body. Removable stand legs when not in use.
CONTROLS	3 section electric valves. Control box with pressure adjustment and on/off switches mounted on arm close to operator.	AGITATION	Bypass action and venturi jet.
TANK	400L Polytuff impact resistant polyethylene construction with calibrated external sightline, non-spill screw-down lid, internal baffle and sump.	PRESSURE GAUGE	0-25 Bar dual stage glycerine filled gauge.
		FILTRATION	Lid strainer and suction line strainer.
		HOSEREEL	Economy hose reel with 20m x 12mm ag hose and JetPro spray gun.

MODEL DESCRIPTION	CODE	PRICE EX. GST	PRICE INC. GST
400L TRAY DE-MOUNTABLE SLED SPRAYER: Sled mounted with BP60/20 coupled to 5.5HP Honda engine, electric controls, economy reel, 20m hose and gun (no boom)	CUSH-07	\$15,000	\$16,500
FACTORY OPTIONS	CODE	PRICE EX. GST	PRICE INC. GST
6m Field boom	032-044-6	\$2,000	\$2,200
6m Hydraulic fold boom	032-19D	\$4,750	\$5,225
16L Paddock foam marker (double sided)	K99-39	\$1,500	\$1,650
Bravo 180S automatic rate controller (includes BP130/20 pump upgrade)	CUSH-12	\$6,500	\$7,150
BP130/20 pump, 132 L/min capacity, 2000kPa driven by 5.5HP Honda	CUSH-15	\$1,350	\$1,485

Note: Not all options will fit all models. Extra charges may apply to fitment of some options.

2000L Orchard Herbicide

**FULL SHIELDED BOOM
AVAILABLE**



Pictured: Trailed 2000L sprayer with optional hydraulic drive pump

MODEL SPECIFICATIONS

PUMP	Silvan self-priming oil-backed diaphragm type with nitrile diaphragms and corrosion resistant, cast anodised aluminium body. BP130/20: 132 L/min. capacity 2000kPa pressure.	FRAME	Galvanised RHS heavy duty steel construction, jockey wheel and adjustable tow hitch.			
CONTROLS	3 section electric valve on/off with electric pressure adjustment from cab mounted control box.	AGITATION	Bypass action.			
TANK	Polytuff impact resistant polyethylene construction, calibrated sight line.	PRESSURE GAUGE	0-25 Bar dual stage glycerine filled gauge.			
BOOM	6 metre fully galvanised hydraulic fold boom with stainless steel spraylines and air induction nozzles. Front mounted boom arms with independent hydraulic fold and rear mounted centre boom.	FILTRATION	Lid strainer, suction line strainer & nozzle strainers.			
		WHEEL EQUIPMENT	Single axle with 31/13.5 x 15" flotation tyres.			
		PTO DRIVESHAFT	Quality driveshaft with quick release pins & safety cover.			
		DIMENSIONS (BOOM FOLDED)	L (MM)	W (MM)	H (MM)	KG (DRY)
		JB2BA-125	3500	1550	2100	440

MODEL DESCRIPTION	CODE	PRICE EX. GST	PRICE INC. GST
2000L TRAILED ORCHARD HERBICIDE SPRAYER: BP130/20 pump and hydraulic fold boom	JB2BA-125	\$33,290	\$36,619
FACTORY FITTED OPTIONS	CODE	PRICE EX. GST	PRICE INC. GST
Spray Rate automatic rate controller	J99-145	\$4,500	\$4,950
Bravo 180S automatic spray rate controller	J99-146	\$6,000	\$6,600
Hydraulic drive centrifugal pump	J99-126	\$3,000	\$3,300

When ordering hydraulic drive pumps, tractor hydraulic capacity and system must be on order. Note: Extra charges may apply to fitment of some options.

Spray Controllers & Accessories

For increased spraying efficiency, various technology options such as automatic spray rate controllers, in-cab electric controls and GPS guidance systems are available.



Guidance Systems & Spray Rate Controllers



AGRONAVE 7

AGRONAVE 7 GUIDANCE FUNCTIONS

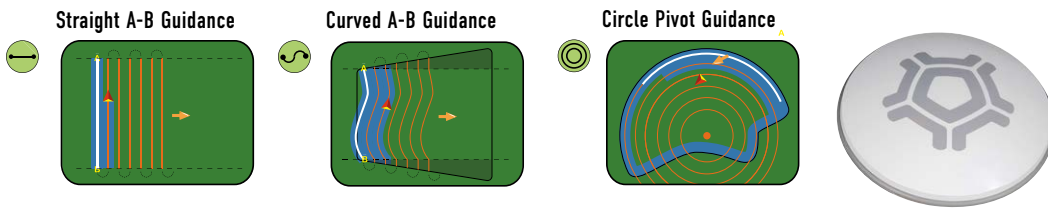

AGRONAVE 7

The Agronave 7 is a complete GPS system with 7" display that provides enhanced visual guidance with a light bar and on screen guidance for spraying, spreading or seeding applications. The Agronave 7 is ISOBUS and autosteer compatible (available through licensing). Application information can be viewed in the cloud based ISOFORM application manager to see where you have sprayed, area covered and time spent.

FEATURES

7" display, USB port, external GPS antenna, triple suction cup mount

DESCRIPTION

AGRONAVE 7 GPS

CODE

G8408008

PRICE EX. GST

\$3,750

PRICE INC. GST

\$4,125



SPRAY RATE CS

SPRAY RATE CONTROLLER KIT SPECIFICATIONS

An easy to use spray controller for constant and precise rate control.

DISTRIBUTION CONTROL

Automatic adjustment of spray application rate by measuring flow and speed.

SECTIONS

Control of up to 7 sections.

KIT CONTENTS

Kit includes control box, tractor loom, sprayer loom and GPS speed sensor.

DISPLAY

Simultaneous display of application rate (L/ha) and: speed, area, sprayed, volume, tank level, flow rate (L/min), operating time and distance.

DESCRIPTION

Spray Rate OS - 4 sections (For horticultural applications)

G5001011400005

PRICE EX. GST

\$4,850

PRICE INC. GST

\$5,335

Spray Rate CS - 7 sections (For broadacre applications)

G5001011400001

\$4,850

\$5,335

Bravo Rate Controller Kits



BRAVO 180S SPRAY RATE CONTROLLER KIT SPECIFICATIONS

A compact and easy to use spray controller that ensures constant and precise rate control.

DISTRIBUTION CONTROL	Automatic adjustment of spray application rate by measuring flow and speed.
SECTIONS	Control of up to 5 sections.
KIT CONTENTS	Kit includes control box, tractor loom, sprayer loom and speed sensor.
DISPLAY	Simultaneous display of application rate (L/ha) and: speed, area, sprayed quantity, tank level, flow rate (L/min), operating time and distance.

DESCRIPTION	CODE	PRICE EX. GST	PRICE INC. GST
ARAG Bravo 180S - 2 sections (For horticultural applications)	BRAVO180SHKIT-1	\$6,500	\$7,150
ARAG Bravo 180S - 4 sections (For multi-row applications)	BRAVO180HKIT	\$6,500	\$7,150
ARAG Bravo 180S - 5 sections (For broadacre applications)	BRAVO180BAKIT	\$6,500	\$7,150

Note: Extra components including electric valves and flow meter may be needed

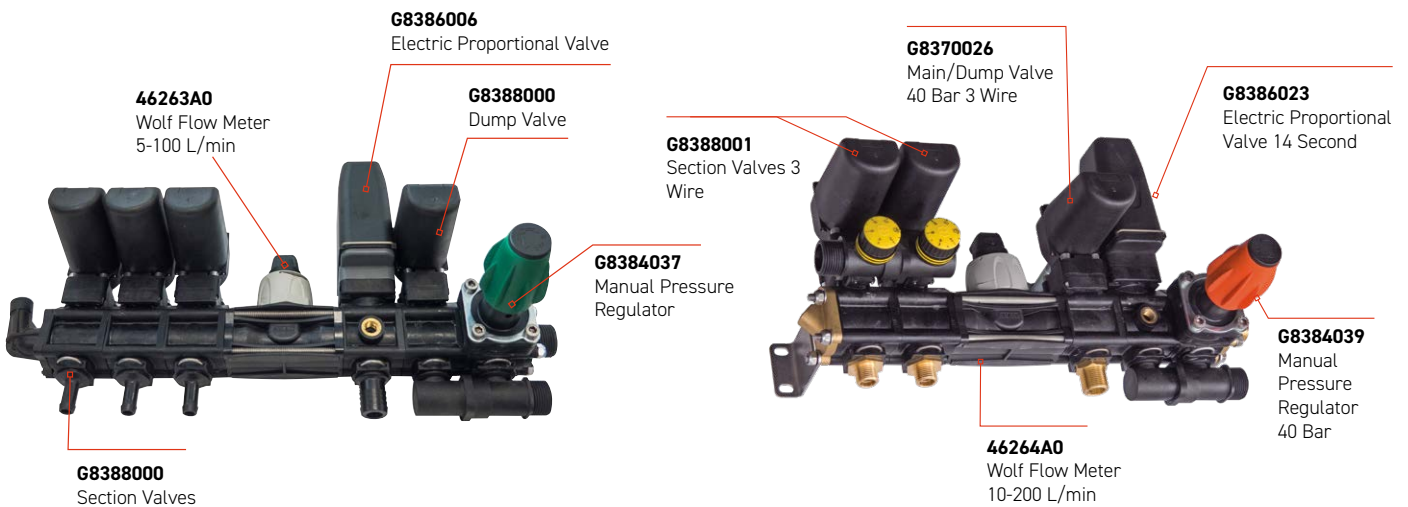

20 BAR SPRAY CONTROLLER VALVE KIT SPECIFICATIONS

Features 3 on/off electric section valves and 1 bypass electric valve, electric pressure regulator, manual pressure regulator and flow meter.

*Extra components such as hoses and mounting brackets may be required.

DESCRIPTION	CODE	PRICE EX. GST	PRICE INC. GST
VALVE BANK TO SUIT BRAVO180BAKIT OR G5001011400001	D99-85	\$2,900	\$3,190

Note: Refer to page 67 for compatible Spray Rate controller kits or above for compatible Bravo 180S spray rate controller kits

40 BAR SPRAY CONTROLLER VALVE KIT SPECIFICATIONS

Supplied complete with 2 on/off electric pressure compensating valves for left or right side spraying and 1 bypass electric valve, electric pressure regulator, manual pressure regulator and flow meter.

*Extra components such as hoses and mounting brackets may be required.

DESCRIPTION	CODE	PRICE EX. GST	PRICE INC. GST
VALVE BANK TO SUIT BRAVO180SHKIT-1 OR G5001011400005	D99-84	\$4,200	\$4,620

Note: Refer to page 67 for compatible Spray Rate controller kits or above for compatible Bravo 180S spray rate controller kits

IOTBOX2 & ISOBUS Kits

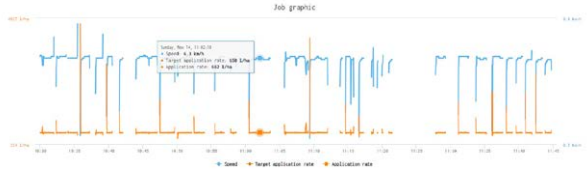

IOTBOX2

The IOTBOX2 is an electronic control unit that connects to your Bravo 180S, Bravo 400S or Delta 80t to collect data from your sprayer so the sprayer can be remotely monitored through the MyBravo platform.

KIT CONTENTS

Electronic control unit, connection cable, GPS antenna and 5 year MyBravo subscription.

NOTE: Rate controller not included – sold separately

DESCRIPTION

IOTBOX2 KIT

CODE

4679705

PRICE EX. GST

\$14,000

PRICE INC. GST

\$15,400



IBX100 ISOBUS SPRAYER CONTROL

An ISOBUS compatible controller designed to integrate with tractor terminals such as John Deere® and Topcon®. It utilises the existing ISOBUS compatible tractor terminal for spray rate control and automatic section control.

CONTROL

Controls up to 13 spray sections, 9 hydraulic controls

DESCRIPTION

IBX100 CONTROL UNIT

CODE

467900KIT

PRICE EX. GST

\$8,600

PRICE INC. GST

\$9,460

OPTIONS

DELTA 80 CONSOLE

CODE

4675103

PRICE EX. GST

\$14,900

PRICE INC. GST

\$16,390

Note: Extra components may be needed

Electric Control Kits



D99-80

SILVAMATIC ELECTRIC SPRAY CONTROL KIT

Features an in-cab control box with proportional pressure compensating valves designed to maintain constant pressure and output even after one or more boom sections are closed.

- Direct acting valves
- Stainless steel components and viton seals
- 3 boom section outlet with 12mm tails
- On/off and pressure adjustment switch
- Individual valves have own compensating device

KIT CONTENTS

Kit includes control box, tractor loom, sprayer loom and valves

DESCRIPTION	CODE	PRICE EX. GST	PRICE INC. GST
SILVAMATIC CONTROL KIT	461530A	\$2,800	\$3,080

Note: Extra components may be needed

HIGH PRESSURE ELECTRIC VALVE KIT

Modular 12 volt DC electric control kit ideal for use on high pressure orchard sprayers (up to 150L/min). Supplied complete with 2 on/off electric valves for left or right side spraying and 1 bypass electric valve, electric pressure regulator and manual pressure regulator. Control switch box suitable for mounting in tractor cabin with electric wiring loom.

KIT CONTENTS

Kit includes control box, tractor loom, sprayer loom and valves

DESCRIPTION	CODE	PRICE EX. GST	PRICE INC. GST
HIGH PRESSURE ELECTRIC VALVE KIT	D99-83	\$1,750	\$1,925

Note: Extra components may be needed

HIGH PRESSURE AND FLOW ELECTRIC VALVE KIT

Modular 12 volt DC electric control kit ideal for use on high pressure orchard sprayers (up to 180L/min). Supplied complete with 2 on/off electric valves for left or right side spraying and 1 bypass electric valve, electric pressure regulator, manual pressure regulator and pressure filter. Control switch box suitable for mounting in tractor cabin with electric wiring loom.

KIT CONTENTS

Includes control box, tractor loom, sprayer loom and valves

DESCRIPTION	CODE	PRICE EX. GST	PRICE INC. GST
HIGH PRESSURE AND FLOW ELECTRIC VALVE KIT	D99-80	\$1,875	\$2,063

Note: excludes pressure gauge

Hydraulic Drive Centrifugal Pumps

SELF PRIMING
CHAMBER



9303S-HM5C-SP



9303C-HM4C

HYDRAULIC DRIVE CENTRIFUGAL PUMP

- Hydraulic motor drive (for open centre, closed centre and load-sensing systems)
- Viton centrifugal shaft seals and double lip Teflon hydraulic motor seal standard
- 1 1/2" NPT inlet, 1 1/4" NPT outlet
- Max. fluid temperature 60°C
- C = Cast iron housing and glass filled nylon impeller
- S = Stainless steel housing
- SP = Self-priming
- Internal gear gerotor motor
- 1/2" NPT hydraulic ports

Note: hydraulic hoses and fittings are not included

CODE	PUMP MAX	MAX HYD. FLOW	MAX. PRESS. KPA/ PSI	MAX. RPM	WEIGHT (KG)	PRICE EX. GST	PRICE INC. GST
9303C-HM4C	435L/min	26.5 L/min	640/93	6000	11.8 kg	\$2,980	\$3,278
9303C-HM4C-SP	375L/min	26.5 L/min	660/96	6000	17.3 kg	\$3,730	\$4,103
9303C-HM5C-SP	530L/min	56.8 L/min	960/139	6000	17.3 kg	\$3,750	\$4,125
9303S-HM4C	435L/min	26.5 L/min	640/93	6000	11.8 kg	\$4,410	\$4,851
9303S-HM4C-SP	435L/min	26.5 L/min	640/93	6000	17.3 kg	\$7,630	\$8,393
9303S-HM5C	556L/min	60 L/min	1000/145	6000	11.8 kg	\$4,410	\$4,851
9303S-HM5C-SP	556L/min	56.8 L/min	1000/145	6000	17.3 kg	\$8,060	\$8,866

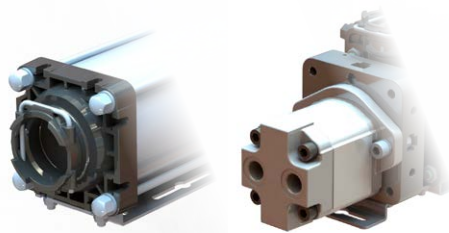

MP400

HYDRAULIC DRIVE MULTI-STAGE CENTRIFUGAL PUMP

- High efficiency (low oil flow)
- Compact (480 x 147 x 188mm)
- Flow rate 400 L/min @ 8 bar (4200 RPM)
- Excellent chemical compatibility

Note: hydraulic hoses and fittings are not included

CODE	PUMP MAX	MAX HYD. FLOW	MAX. PRESS. KPA/ PSI	MAX. RPM	WEIGHT (KG)	PRICE EX. GST	PRICE INC. GST
97005021	517 L/min	26.5 L/min	750/109	4200	9.6	\$4,320	\$4,752
97005001	560 L/min	49.2 L/min	1060/154	4200	9.8	\$4,320	\$4,752
97005031	567 L/min	64.3 L/min	1100/160	4200	10	\$4,320	\$4,752

High Pressure Diaphragm Pumps

APS SERIES

All Silvan APS series high pressure diaphragm pumps are built for 540 RPM operation, are self-priming and feature a corrosion resistant cast anodised aluminium body. Tough and reliable they will run dry without risk of damage. All pumps are supplied with appropriate hose connections, mounting base plates and 1 3/8" six splined shaft.

APS71

- Diaphragms: 3
- Output @ 540 RPM: 67 L/min
- Max. pressures (kPa/psi): 5000/725
- Shaft: Male - Female or Male - Male
- HP required at max. pressure: 9.1
- L x W x H (mm): 238 x 343 x 289
- Weight (kg): 18.4

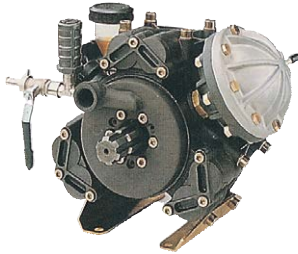

APS145

- Diaphragms: 4
- Output @ 540 RPM: 142 L/min
- Max. pressures (kPa/psi): 5000/725
- Shaft: Male - Male
- HP required at max. pressure: 18
- L x W x H (mm): 342 x 380 x 420
- Weight (kg): 46

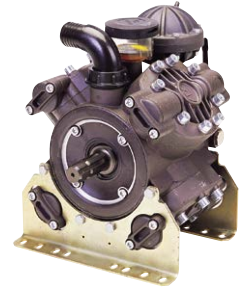

APS96

- Diaphragms: 4
- Output @ 540 RPM: 88 L/min
- Max. pressures (kPa/psi): 5000/725
- Shaft: Male - Female or Male - Male
- HP required at max. pressure: 11.7
- L x W x H (mm): 236 x 345 x 340
- Weight (kg): 22.5



APS166

- Diaphragms: 5
- Output @ 540 RPM: 163 L/min
- Max. pressures (kPa/psi): 5000/725
- Shaft: Male - Male
- HP required at max. pressure: 20.5
- L x W x H (mm): 370 x 389 x 420
- Weight (kg): 56

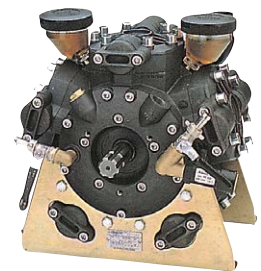

APS121

- Diaphragms: 3
- Output @ 540 RPM: 115 L/min
- Max. pressures (kPa/psi): 5000/725
- Shaft: Male - Male
- HP required at max. pressure: 14.5
- L x W x H (mm): 329 x 387 x 356
- Weight (kg): 38

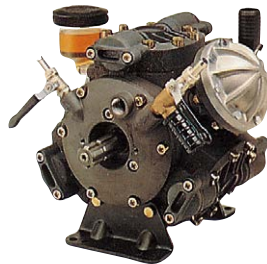

BRASS MANUAL CONTROL VALVE 00711511

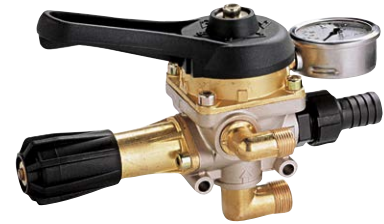

MODEL SPECIFICATIONS

PUMP	L/MIN @ MAX PRESSURE	MAX PRESSURE (kPa)	KG	SHAFT	CODE	PRICE EX. GST	PRICE INC. GST
APS71	67	5000	18.4	Male - Female	CAPS071	\$1,750	\$1,925
APS71	67	5000	18.4	Male - Male	CAPS071S	\$1,750	\$1,925
APS96	88	5000	22.5	Male - Female	CAPS096MF	\$1,950	\$2,145
APS96	88	5000	22.5	Male - Male	CAPS096	\$1,950	\$2,145
APS121	115	5000	38.0	Male - Male	CAPS121	\$3,200	\$3,520
APS145	142	5000	46.0	Male - Male	CAPS145	\$3,050	\$3,355
APS166	163	5000	56.0	Male - Male	CAPS166	\$4,100	\$4,510
BRASS MANUAL CONTROL VALVE	Suitable for APS series, IDS1701 pumps				00711511	\$900	\$990

SERVICE KITS

CODE	PUMP	MATERIAL	SHAFT
CSKAPS71	APS71	NBR	SPLINED
C5026-228	APS96	NBR	SPLINED
CSKAPS121	APS121	NBR	SPLINED
C5026-222	APS145	NBR	SPLINED
C5026-224	APS166	NBR	SPLINED



High Pressure Diaphragm Pumps

IDS SERIES

All Silvan IDS series high pressure diaphragm pumps are built for 540 RPM operation, are self-priming & feature a corrosion resistant cast anodised aluminium body with brass heads and manifold. Tough and reliable they will run dry without risk of damage. All pumps are supplied with appropriate hose connections, mounting base plates and 1 3/8" six splined shaft.

IDS960

- Diaphragms: 4
- Output @ 540 RPM: 93 L/min
- Max. pressures (kPa/psi): 5000/725
- Shaft: Male - Male
- HP required at max. pressure: 11.5
- L x W x H (mm): 268 x 350 x 334
- Weight (kg): 30.3

IDS1401

- Diaphragms: 3
- Output @ 540 RPM: 135 L/min
- Max. pressures (kPa/psi): 5000/725
- Shaft: Male - Male
- HP required at max. pressure: 16.6
- L x W x H (mm): 298 x 404 x 396
- Weight (kg): 53



IDS960 / IDS1401

IDS1701

- Diaphragms: 4
- Output @ 540 RPM: 161 L/min
- Max. pressures (kPa/psi): 5000/725
- Shaft: Male - Male
- HP required at max. pressure: 19.9
- L x W x H (mm): 298 x 499 x 396
- Weight (kg): 60

IDS2001

- Diaphragms: 4
- Output @ 540 RPM: 182 L/min
- Max. pressures (kPa/psi): 5000/725
- Shaft: Male - Male
- HP required at max. pressure: 22.4
- L x W x H (mm): 298 x 499 x 396
- Weight (kg): 60



IDS1701 / IDS2001

IDS2200

- Diaphragms: 6
- Output @ 540 RPM: 208 L/min
- Max. pressures (kPa/psi): 5000/725
- Shaft: Male - Male
- HP required at max. pressure: 26.2
- L x W x H (mm): 357 x 463 x 500
- Weight (kg): 76

IDS2600

- Diaphragms: 6
- Output @ 540 RPM: 249 L/min
- Max. pressures (kPa/psi): 5000/725
- Shaft: Male - Male
- HP required at max. pressure: 32.1
- L x W x H (mm): 357 x 463 x 500
- Weight (kg): 76



IDS2200 / IDS2600

MODEL SPECIFICATIONS

PUMP	L/MIN @50 BAR MAX PRESSURE	MAX PRESSURE (kPa)	KG	SHAFT	CODE	PRICE EX. GST	PRICE INC. GST
IDS960	93	5000	30.3	Male - Male	CDS960	\$3,400	\$3,740
IDS1401	135	5000	45.0	Male - Male	CDS1401	\$4,350	\$4,785
IDS1701	161	5000	60.0	Male - Male	CDS1701	\$4,400	\$4,840
IDS2001	182	5000	60.0	Male - Male	CDS2001	\$5,500	\$6,050
IDS2200	208	5000	76.0	Male - Male	CDS2200-1	\$7,000	\$7,700
IDS2600	249	5000	76.0	Male - Male	CDS2600-1	\$7,990	\$8,789

SERVICE KITS

CODE	PUMP	MATERIAL	SHAFT
C5026-346*	IDS960	NBR	SPLINED
C5026-278*	IDS1401	NBR	SPLINED
C5026-279*	IDS1701, IDS2001	NBR	SPLINED
C5026-208	IDS2200, IDS2600	NBR	SPLINED

*Service kits include valve assemblies, accumulator diaphragm, piston diaphragms only.

Spraying Information

HCC/HCI 80° CERAMIC HOLLOW CONE NOZZLES

		CAPACITY (L/min)																	
		3 BAR	4 BAR	5 BAR	6 BAR	7 BAR	8 BAR	9 BAR	10 BAR	11 BAR	12 BAR	13 BAR	14 BAR	15 BAR	16 BAR	17 BAR	18 BAR	19 BAR	20 BAR
HCC005	HCI80005	0.19	0.22	0.25	0.27	0.29	0.31	0.33	0.35	0.36	0.38	0.40	0.41	0.42	0.44	0.45	0.47	0.48	0.49
HCC0075	HCI800075	0.30	0.35	0.39	0.42	0.46	0.49	0.52	0.55	0.57	0.60	0.62	0.65	0.67	0.69	0.71	0.73	0.75	0.77
HCC01	HCI8001	0.40	0.46	0.52	0.57	0.61	0.65	0.69	0.73	0.77	0.80	0.83	0.86	0.89	0.92	0.95	0.98	1.01	1.03
HCC015	HCI80015	0.60	0.69	0.77	0.85	0.92	0.98	1.04	1.10	1.15	1.20	1.25	1.30	1.34	1.39	1.43	1.47	1.51	1.55
HCC02	HCI8002	0.80	0.92	1.03	1.13	1.22	1.31	1.39	1.46	1.53	1.60	1.67	1.73	1.79	1.85	1.90	1.96	2.01	2.07
HCC025	HCI80025	1.00	1.15	1.29	1.41	1.53	1.63	1.73	1.83	1.91	2.00	2.08	2.16	2.24	2.31	2.38	2.45	2.52	2.58
HCC03	HCI8003	1.20	1.39	1.55	1.70	1.83	1.96	2.08	2.19	2.30	2.40	2.50	2.59	2.68	2.77	2.86	2.94	3.02	3.10
HCC035	HCI80035	1.40	1.62	1.81	1.98	2.14	2.29	2.42	2.56	2.68	2.80	2.91	3.02	3.13	3.23	3.33	3.43	3.52	3.61
HCC04	HCI8004	1.60	1.85	2.07	2.26	2.44	2.61	2.77	2.92	3.06	3.20	3.33	3.46	3.58	3.70	3.81	3.92	4.03	4.13
HCC05	HCI8005	2.00	2.31	2.58	2.83	3.06	3.27	3.46	3.65	3.83	4.00	4.16	4.32	4.47	4.62	4.76	4.90	5.03	5.16
HCC06	HCI8006	2.40	2.77	3.10	3.39	3.67	3.92	4.16	4.38	4.60	4.80	5.00	5.18	5.37	5.54	5.71	5.88	6.04	6.20

HCI 40° CERAMIC HOLLOW CONE NOZZLES

		CAPACITY (L/min)																	
		3 BAR	4 BAR	5 BAR	6 BAR	7 BAR	8 BAR	9 BAR	10 BAR	11 BAR	12 BAR	13 BAR	14 BAR	15 BAR	16 BAR	17 BAR	18 BAR	19 BAR	20 BAR
HCI4001		0.40	0.46	0.52	0.57	0.61	0.65	0.69	0.73	0.77	0.80	0.83	0.86	0.89	0.92	0.95	0.98	1.01	1.03
HCI40015		0.60	0.69	0.77	0.85	0.92	0.98	1.04	1.10	1.15	1.20	1.25	1.30	1.34	1.39	1.43	1.47	1.51	1.55
HCI4002		0.80	0.92	1.03	1.13	1.22	1.31	1.39	1.46	1.53	1.60	1.67	1.73	1.79	1.85	1.90	1.96	2.01	2.07
HCI40025		1.00	1.15	1.29	1.41	1.53	1.63	1.73	1.83	1.91	2.00	2.08	2.16	2.24	2.31	2.38	2.45	2.52	2.58
HCI4003		1.20	1.39	1.55	1.70	1.83	1.96	2.08	2.19	2.30	2.40	2.50	2.59	2.68	2.77	2.86	2.94	3.02	3.10
HCI40035		1.40	1.62	1.81	1.98	2.14	2.29	2.42	2.56	2.68	2.80	2.91	3.02	3.13	3.23	3.33	3.43	3.52	3.61
HCI4004		1.60	1.85	2.07	2.26	2.44	2.61	2.77	2.92	3.06	3.20	3.33	3.46	3.58	3.70	3.81	3.92	4.03	4.13
HCI4005		2.00	2.31	2.58	2.83	3.06	3.27	3.46	3.65	3.83	4.00	4.16	4.32	4.47	4.62	4.76	4.90	5.03	5.16
HCI4006		2.40	2.77	3.10	3.39	3.67	3.92	4.16	4.38	4.60	4.80	5.00	5.18	5.37	5.54	5.71	5.88	6.04	6.20

CERAMIC DISC AND SWIRL PLATES (OUTPUT IN LITRES PER MINUTE)

NOZZLE (SIZE)	SWIRL PLATE (CENTRE SIZE)	10 BAR	15 BAR	20 BAR	25 BAR	30 BAR	40 BAR	50 BAR
MA1-08 (0.8)	MA2-00 (Closed Centre)	0.9	1.0	1.2	1.3	1.4	1.6	1.9
MA1-10 (1.0)	MA2-00 (Closed Centre)	1.3	1.5	1.7	1.9	2.1	2.4	2.7
MA1-12 (1.2)	MA2-00 (Closed Centre)	1.7	2.0	2.3	2.6	2.8	3.2	3.5
MA1-15 (1.5)	MA2-00 (Closed Centre)	2.3	2.7	3.1	3.3	3.6	4.0	4.3
MA1-18 (1.8)	MA2-00 (Closed Centre)	2.7	3.2	3.6	4.1	4.5	5.0	5.5
MA1-20 (2.0)	MA2-00 (Closed Centre)	3.4	3.8	4.3	4.7	5.1	5.7	6.3
MA1-22 (2.2)	MA2-00 (Closed Centre)	3.8	4.1	4.6	5.1	5.6	6.6	7.4
MA1-25 (2.5)	MA2-00 (Closed Centre)	3.9	4.7	5.4	6.0	6.6	7.7	8.5
MA1-10 (1.0)	MA2-10 (1.0)	1.6	1.9	2.2	2.4	2.6	3.0	3.4
MA1-12 (1.2)	MA2-10 (1.0)	2.5	3.0	3.4	3.8	4.1	4.7	5.4
MA1-15 (1.5)	MA2-12 (1.2)	3.6	4.2	4.8	5.3	5.8	6.9	7.7
MA1-18 (1.8)	MA2-15 (1.5)	5.0	5.9	6.7	7.4	8.0	9.5	10.6
MA1-20 (2.0)	MA2-18 (1.8)	6.2	7.8	8.7	9.6	10.4	11.8	13.2
MA1-22 (2.2)	MA2-20 (2.0)	7.4	8.7	9.9	11.2	12.5	14.3	16.4
MA1-25 (2.5)	MA2-22 (2.2)	8.8	10.5	12.1	13.5	14.7	16.2	17.5



MA1-10



MA2-10

Spraying Information

CALCULATIONS REQUIRED FOR OUTPUT PER NOZZLE

$$\text{L/min/nozzle} = \frac{\text{L/ha} \times \text{km/h} \times \text{row width (m)}}{600 \times \text{no. of nozzles}}$$

eg: $\frac{500 \times 7 \times 3}{600 \times 16} = 1.09 \text{ L/min/nozzle}$

PUMP MODEL	CAPACITY (FULL PRESS)	MAX PRESURE
BP20/15	19 L/min.	15 bar
BP60/20	58 L/min.	20 bar
BP75/15	71 L/min.	20 bar
BP130/20	132 L/min.	20 bar
BP151/20	138 L/min.	20 bar
BP171/20	162 L/min.	20 bar
BP265/20	252 L/min.	20 bar

EXAMPLE:

Application rate: 100 l/ha
 Tractor speed: 12 km/h
 Boom width: 10 m
 Tank capacity: 800L
 Pump output required = $\frac{100 \times 12 \times 10}{600}$
 = 20 L/min

PUMP MODEL	CAPACITY (FULL PRESS)	MAX PRESURE
APS 71	67 L/min.	50 bar
APS 96	88 L/min.	50 bar
APS 121	115 L/min.	50 bar
APS 145	142 L/min.	50 bar
APS 166	163 L/min.	50 bar
IDS 1701	161 L/min.	50 bar
IDS 2001	182 L/min.	50 bar
IDS 2200	208 L/min.	50 bar
IDS 2600	249 L/min.	50 bar

EXAMPLE:

Application rate: 2000 l/ha
 Tractor speed: 5 km/h
 Tree spacing: 5 m
 Tank capacity: 2000L
 Pump output required = $\frac{2000 \times 5 \times 5}{600}$
 = 83.3 l/min

FINDING THE RIGHT PUMP

SILVAN LINKAGE OR TRAILED SPRAYER

STEP 1 Determine the application rate, boom width (in metres) and the tractor speed for the job.

STEP 2 Allow between 2% and 5% of the tank volume to be recirculated every minute to provide agitation. If venturi agitators are used, allow for the volume of liquid used by the venturi jet. When venturi's are used they usually become the primary method of agitation so the allowance for the percentage of tank volume to be recirculated can be disregarded. There is always agitation from the pump (diaphragm or piston type) when it is in bypass mode.

STEP 3 Use the following formula to calculate the pump output required by the boom.

$$\text{Pump output required (l/min)} = \frac{\text{Application rate (l/ha)} \times \text{Speed (km/h)} \times \text{Boom width (m)}}{600}$$

STEP 4 Allow 2% tank volume for agitation (example 800 x 2% = 16L/min.) Add this amount to required pump output for spraying to find total volume required from pump (example 20 + 16 = 36L/min).

STEP 5 Select a pump from the table at right to match required total output.

SILVAN AIR ASSIST SPRAYER

STEP 1 Determine the application rate (l/ha), the tractor speed and the row width of the crop being sprayed.

STEP 2 Allow between 2% and 5% of the tank capacity to be recirculated every minute for agitation. The lower percentage can be used where mechanical agitation is fitted.

STEP 3 Use the following formula to calculate the pump output required by the sprayer.

$$\text{Pump output (l/min)} = \frac{\text{Application rate (l/ha)} \times \text{Speed (km/h)} \times \text{Row width (m)}}{600}$$

STEP 4 Allow 2% tank volume for agitation (eg 2000 x 2% = 40L/min). Add this amount to required pump output for spraying to find the total volume required from the pump (example 83.3L/min + 40L/min = 123.3L/min).

STEP 5 Select a pump from the table above to match required total output.

NOTE: From the above table either the APS 145 or APS 166 would be suitable, but the APS 166 will give more flexibility if larger application rates are needed.

BRASS BOOMLESS NOZZLES

CODE	NOZZLE A	NOZZLE B	NOZZLE C	PRESSURE (BAR)	FLOW (L/MIN)	WIDTH (M)	RATE (L/HA)				
							6 KM/H	8 KM/H	12 KM/H	16 KM/H	24 KM/H
5880-3/4-2TOC06	6733-OC06	H1/4VV- 1506	H1/4VVL-9502 with 50 mesh strainer	1.5	7.26	10.2	71.2	53.4	35.6	26.7	17.8
				2.0	8.38	10.3	81.4	61.0	40.7	30.5	20.3
				2.5	9.37	10.5	89.2	66.9	44.6	33.5	22.3
5880-3/4-2TOC10	OC-10	H1/4U-0508HE	H1/4VVL-11004 with 50 mesh strainer	1.5	11.16	12.0	93.0	69.8	46.5	34.9	23.3
				2.0	12.89	12.1	107.0	79.9	53.3	39.9	26.3
				2.5	14.41	12.3	117.0	87.9	58.6	43.9	29.3
5880-3/4-2TOC20	OC-20	H1/4U-0520HE	H1/4VVL-9506 with 50 mesh strainer	1.5	24.00	14.3	168.0	126.0	83.9	62.9	42.0
				2.0	27.72	15.2	182.0	137.0	91.2	68.4	45.6
				2.5	30.99	15.8	196.0	147.0	98.1	73.6	49.0
5880-3/4-2TOC40	OC-40	H1/4U-0540HE	H1/4U-9510	1.5	47.44	17.1	277.0	208.0	139.0	104.0	69.4
				2.0	54.78	18.2	300.0	226.0	150.0	113.0	75.2
				2.5	61.25	19.2	319.0	239.0	160.0	120.0	79.8
K99-10	BOOMLESS NOZZLE MOUNTING KIT (BRASS NOZZLE NOT INCLUDED)										

Spraying Information

Nozzle selection is often based upon droplet size. The droplet size from a nozzle becomes very important when the efficacy of a particular plant protection chemical is dependent on coverage, or the prevention of spray leaving the target area is a priority. Refer to the chemical label for droplet size regulations.

The majority of the nozzles used in agriculture can be classified as producing either fine, medium, coarse, or very coarse droplets. Nozzles that produce fine droplets are usually recommended for post-emergence applications, which require excellent coverage on the intended target area. The most common nozzles used in agriculture are those that produce medium sized droplets. Nozzles producing medium and coarse-sized droplets can be used for contact and systemic herbicides, pre-emergence surface-applied herbicides, insecticides and fungicides.

An important point to remember when choosing a spray nozzle that produces a droplet size in one of the seven categories is that one nozzle can produce different droplet size classifications at different pressures. A nozzle might produce medium droplets at low pressures, while producing fine droplets as the pressure is increased. Droplet size classes are shown in the following tables to assist in choosing an appropriate spray tip.

	TP Teejet				
	BAR				
	2	2.5	3	3.5	4
TP8001	F	F	F	F	F
TP80015	F	F	F	F	F
TP8002	M	M	F	F	F
TP8003	M	M	M	M	M
TP8004	M	M	M	M	M
TP8005	C	M	M	M	M
TP8006	C	C	C	C	C
TP8008	C	C	C	C	C
TP11001	F	F	F	VF	VF
TP110015	F	F	F	F	F
TP11002	F	F	F	F	F
TP11003	F	F	F	F	F
TP11004	M	M	M	F	F
TP11005	M	M	M	M	M
TP11006	M	M	M	M	M
TP11008	C	C	M	M	M

	XR Teejet and XRC Teejet						
	BAR						
	1	1.5	2	2.5	3	3.5	4
XR8001	M	F	F	F	F	F	F
XR80015	M	M	F	F	F	F	F
XR8002	M	M	M	M	F	F	F
XR8003	M	M	M	M	M	M	M
XR8004	C	M	M	M	M	M	M
XR8005	C	C	C	M	M	M	M
XR8006	C	C	C	C	C	C	C
XR8008	VC	VC	C	C	C	C	C
XR11001	F	F	F	F	F	VF	VF
XR110015	F	F	F	F	F	F	F
XR11002	M	F	F	F	F	F	F
XR110025	M	M	F	F	F	F	F
XR11003	M	M	F	F	F	F	F
XR11004	M	M	M	M	M	F	F
XR11005	C	M	M	M	M	M	M
XR11006	C	C	M	M	M	M	M
XR11008	C	C	C	C	M	M	M

	DG Teejet				
	BAR				
	2	2.5	3	3.5	4
DG80015	M	M	M	M	F
DG8002	C	M	M	M	M
DG8003	C	M	M	M	M
DG8004	C	C	M	M	M
DG8005	C	C	C	M	M
DG110015	M	F	F	F	F
DG11002	M	M	M	M	M
DG11003	C	M	M	M	M
DG11004	C	C	M	M	M
DG11005	C	C	C	M	M

	Turbo Teejet Induction (TTI)											
	BAR											
	1	1.5	2	2.5	3	3.5	4	4.5	5	5.5	6	7
TTI10015	UC	UC	UC	UC	UC	UC	XC	XC	XC	XC	XC	XC
TTI11002	UC	UC	UC	UC	UC	UC	XC	XC	XC	XC	XC	XC
TTI110025	UC	UC	UC	UC	UC	UC	XC	XC	XC	XC	XC	XC
TTI11003	UC	UC	UC	UC	UC	UC	XC	XC	XC	XC	XC	XC
TTI11004	UC	UC	UC	UC	UC	UC	XC	XC	XC	XC	XC	XC
TTI11005	UC	UC	UC	UC	UC	UC	XC	XC	XC	XC	XC	XC
TTI11006	UC	UC	UC	UC	UC	UC	XC	XC	XC	XC	XC	XC

	Turbo Twinjet (TTJ60)									
	BAR									
	1.5	2	2.5	3	3.5	4	4.5	5	5.5	6
TTJ60-11002	C	C	C	C	M	M	M	M	M	M
TTJ60-110025	VC	C	C	C	C	C	M	M	M	M
TTJ60-11003	VC	C	C	C	C	C	C	M	M	M
TTJ60-11004	VC	C	C	C	C	C	C	C	M	M
TTJ60-11005	VC	C	C	C	C	C	C	C	C	C
TTJ60-11006	XC	VC	C	C	C	C	C	C	C	C

	IDK Lechler						
	BAR						
	1.5	2	2.5	3	4	5	6
IDK12001 IDKS8001	C	C	C	M	M	M	F
IDK120015 IDKS80015	C	C	C	C	M	M	F
IDK12002 IDKS8002	C	C	C	C	M	M	F
IDK120025 IDKS80025	VC	VC	C	C	C	M	M
IDK12003 IDKS8003	VC	VC	VC	C	C	M	M
IDK12004 IDKS8004	VC	VC	VC	VC	C	C	M
IDK12005 IDKS8005	VC	VC	VC	VC	C	C	M

	AIXR Teejet										
	BAR										
	1	1.5	2	2.5	3	3.5	4	4.5	5	5.5	6
AIXR110015	XC	VC	VC	C	C	C	C	M	M	M	M
AIXR11002	XC	XC	VC	VC	C	C	C	C	M	M	M
AIXR110025	XC	XC	XC	VC	VC	C	C	C	C	C	C
AIXR11003	XC	XC	XC	VC	VC	C	C	C	C	C	C
AIXR11004	UC	XC	XC	XC	VC	VC	VC	C	C	C	C
AIXR11005	UC	XC	XC	XC	XC	VC	VC	VC	C	C	C
AIXR11006	UC	XC	XC	XC	XC	VC	VC	VC	C	C	C

	HCC Spray-Jet						
	BAR						
	3	4	5	6	8	10	15
HCC005	VF	VF	VF	VF	VF	VF	VF
HCC0075	F	VF	VF	VF	VF	VF	VF
HCC01	F	VF	VF	VF	VF	VF	VF
HCC015	F	F	VF	VF	VF	VF	VF
HCC02	F	F	F	VF	VF	VF	VF
HCC025	F	F	F	VF	VF	VF	VF
HCC03	F	F	F	VF	VF	VF	VF
HCC035	F	F	F	VF	VF	VF	VF
HCC04	F	F	F	F	F	VF	VF
HCC05	F	F	F	F	F	F	VF

	CFA Air Induction Nozzles				
	BAR				
	1.5	3	5	7	8
CFA110015	VC	C	C	C	M
CFA11002	XC	C	C	C	C
CFA110025	XC	VC	C	C	C
CFA11003	XC	VC	VC	C	C
CFA11004	XC	XC	VC	C	C
CFA11005	XC	XC	VC	VC	C
CFA11006	XC	XC	VC	VC	C

	AI Teejet and AIC Teejet											
	BAR											
	2	2.5	3	3.5	4	4.5	5	5.5	6	6.5	7	8
AI110015	UC	XC	XC	XC	XC	VC	VC	VC	VC	C	C	C
AI11002	UC	XC	XC	XC	XC	VC	VC	VC	VC	C	C	C
AI110025	UC	UC	XC	XC	XC	XC	VC	VC	VC	C	C	C
AI11003	UC	UC	XC	XC	XC	XC	VC	VC	VC	C	C	C
AI11004	UC	UC	XC	XC	XC	XC	VC	VC	VC	C	C	C
AI11005	UC	UC	XC	XC	XC	XC	VC	VC	VC	C	C	C
AI11006	UC	UC	XC	XC	XC	XC	VC	VC	VC	C	C	C
AI11008	UC	UC	XC	XC	XC	XC	VC	VC	VC	C	C	C
AI11010	UC	UC	XC	XC	XC	XC	VC	VC	VC	C	C	C

	Turbo Teejet and Turbo Teejet Duo										
	BAR										
	1	1.5	2	2.5	3	3.5	4	4.5	5	5.5	6
TT11001 QJ90-2XTT11001	C	M	M	M	F	F	F	F	F	F	F
TT110015 QJ90-2XTT110015	C	C	M	M	M	M	M	F	F	F	F
TT11002 QJ90-2XTT11002	C	C	C	M	M	M	M	M	M	F	F
TT110025 QJ90-2XTT110025	VC	C	C	M	M	M	M	M	M	M	M
TT11003 QJ90-2XTT11003	VC	C	C	C	C	M	M	M	M	M	M
TT11004 QJ90-2XTT11004	XC	VC	C	C	C	C	C	C	M	M	M
TT11005 QJ90-2XTT11005	XC	VC	VC	VC	C	C	C	C	C	M	M
TT11006 QJ90-2XTT11006	XC	VC	VC	VC	C	C	C	C	C	C	M
TT11008 QJ90-2XTT11008	XC	XC	VC	VC	C	C	C	C	C	C	M

KEY	
DROPLET SIZE COLOUR REFERENCE	
VERY FINE	VF
FINE	F
MEDIUM	M
COARSE	C
VERY COARSE	VC
EXTRA COARSE	XC
ULTRA COARSE	UC
Droplet size classifications are based on BCPC specifications and in accordance with ASAE Standard S-572 at the date of printing. Classifications are subject to change.	

Spraying Information

ISO STANDARD NOZZLE OUTPUT CHART FOR 80°/110° NOZZLES

ISO COLOUR CODE	LIQ PRES BAR	CAPACITY L/MIN.	APPLICATION RATE:LS PER HECTARE AT KM/H.												
			6 km/h	8 km/h	10 km/h	12 km/h	14 km/h	16 km/h	18 km/h	20 km/h	22 km/h	24 km/h	26 km/h	28 km/h	30 km/h
FAN TIP ORANGE 80-01 110-01 100 MESH	2.0	0.33	65	49	39	33	28	24	22	20	18	16	15	14	13
	2.5	0.37	73	55	44	37	31	27	24	22	20	18	17	16	15
	3.0	0.40	80	60	48	40	34	30	27	24	22	20	18	17	16
	3.5	0.43	86	65	52	43	37	32	29	26	23	22	20	18	17
FAN TIP GREEN 80-015 110-015 100 MESH	2.0	0.49	98	74	59	49	42	37	33	29	27	25	23	21	20
	2.5	0.55	110	82	66	55	47	41	37	33	30	27	25	23	22
	3.0	0.60	120	90	72	60	51	45	40	36	33	30	28	26	24
	3.5	0.65	130	97	78	65	56	49	43	39	35	32	30	28	26
FAN TIP YELLOW 80-02 110-02 50 MESH	2.0	0.65	131	98	78	65	56	49	44	39	36	33	30	28	26
	2.5	0.73	146	110	88	73	63	55	49	44	40	37	34	31	29
	3.0	0.80	160	120	96	80	69	60	53	48	44	40	37	34	32
	3.5	0.86	173	130	104	86	74	65	58	52	47	43	40	37	35
FAN TIP BLUE 80-03 110-SF-03 50 MESH	2.0	0.98	196	147	118	98	84	74	65	59	53	49	45	42	39
	2.5	1.10	219	164	131	110	94	82	73	66	60	55	51	47	44
	3.0	1.20	240	180	144	120	103	90	80	72	65	60	55	51	48
	3.5	1.30	259	194	156	130	111	97	86	78	71	65	60	56	52
FAN TIP RED 80-04 110-04 50 MESH	2.0	1.31	261	196	157	131	112	98	87	78	71	65	60	56	52
	2.5	1.46	292	219	175	146	125	110	97	88	80	73	67	63	58
	3.0	1.60	320	240	192	160	137	120	107	96	87	80	74	69	64
	3.5	1.73	346	259	207	173	148	130	115	104	94	86	80	74	69
FAN TIP BROWN 80-05 110-05 50 MESH	2.0	1.63	326	245	196	163	140	122	109	98	89	82	75	70	65
	2.5	1.82	364	273	218	182	156	137	121	109	99	91	84	78	73
	3.0	2.00	400	300	240	200	171	150	133	120	109	100	92	86	80
	3.5	2.16	432	324	259	216	185	162	144	130	118	108	100	93	86
FAN TIP GREY 80-06 110-06 50 MESH	2.0	1.96	392	294	235	196	168	147	131	118	107	98	90	84	78
	2.5	2.19	438	329	263	219	188	164	146	131	120	110	101	94	88
	3.0	2.40	480	360	288	240	206	180	160	144	131	120	111	103	96
	3.5	2.59	518	389	311	259	222	194	173	156	141	130	120	111	104
FAN TIP WHITE 80-08 110-08 50 MESH	2.0	2.61	522	392	313	261	224	196	174	157	142	131	120	112	104
	2.5	2.92	584	438	350	292	250	219	195	175	159	146	135	125	117
	3.0	3.20	640	480	384	320	274	240	213	192	175	160	148	137	128
	3.5	3.46	692	519	415	346	297	260	231	208	189	173	160	148	138
	4.0	3.70	740	555	444	370	317	278	247	222	202	185	171	159	148

Factors affecting Calibration of Boom Sprays

1. Application rate in Litres per hectare
2. Travel Speed of Tractor

The tractor travel speed is the most important variable in sprayer performance. A 10% change in tractor speed gives a 10% change in application rate. This can lead to over or under application of chemicals. Determine the speed by measuring 100 metres then time in seconds how long it takes to cover the 100 metres. If spraying in hilly terrain time distance both up hill and down hill and average the results.

THE FORMULA FOR SPEED IS:

$$\text{km/h} = \frac{360}{\text{Time in seconds for 100 metres}}$$

3. Nozzle Spacing on boom (Std nozzle spacing is 50 cm).

4. Calculate required output per nozzle:

$$\text{L/min/nozzle} = \frac{\text{L/ha} \times \text{km/h} \times \text{nozzle spacing (cm)}}{60,000}$$

$$\text{e.g. } \frac{100 \times 10 \times 50}{60,000} = 0.83 \text{ L/min/nozzle}$$

Where application rate is: 100 L/Ha, speed is 10 km/h and nozzle spacing is 50 cm. Use the nozzle output charts to select the correct nozzle tip for your application.

5. Check the calibration procedure

Use a measuring jug and stopwatch to check the output of several nozzles across the boom at the recommended pressure. If the outputs vary slightly from the chart then adjust the pressure in the system to achieve the correct volume. If nozzle flow rates are greater than 5% above or below the manufacturer's charts then the whole sprayer system needs to be checked for leaks, blockages etc. cleaned out and the calibration process repeated until accuracy is attained.

The nozzle charts also allow application rates to be determined if the tractor speed, the nozzle and the spraying pressure are known.

Terms and Conditions

AVAILABILITY

Products in the Silvan Spraying Equipment Product Guide are available through authorised Silvan dealers.

TERMS

The Silvan terms and conditions are set out in your individual trading terms and at www.silvan.com.au/terms.

Price

All Prices are suggested list Price in AU dollars. Price are subject to change without prior notice. For stocking incentive programmes refer to your individual trading terms, or contact customer services staff on 1300 745 826.

GST

All Price are shown both inclusive of GST and exclusive of GST.
All invoices will include GST.

FREIGHT CHARGES

Freight and handling charges apply and will be added to the invoice amount. Please refer to the Silvan Spraying & Farm Equipment freight policy or check with Silvan Customer Service for freight charges into your area.

TITLE AND RISK

Silvan retains title to all goods until paid for in full in clear funds. Risk in relation to any Goods passes to the Customer on delivery of the Goods. Delivery of Goods will take place at the Supplier's premises at the time of collection of the Goods by the Customer, its, employees, agent or contractors. If the Supplier has expressly agreed to ship the Goods risk in the Goods passes immediately upon delivery of the Goods from the possession of the Supplier to the Customer's designated place of delivery.

PPSA

Silvan may register a security interest over the goods as security for any payment. You will need to provide Silvan with all information, documents and consents as Silvan requires to register and maintain this security interest.

MINIMUM ORDER VALUE

A \$75 Minimum Order Value (Excl. GST) applies to all standard orders. Orders under the required minimum value will attract a \$25 handling charge (Excl. GST). A \$250 Minimum Order Value (Excl. GST) applies to hardware range orders. Urgent/breakdown orders don't have a required Minimum Order Value, and attract a \$25 priority fee (Excl. GST).

WARRANTY

The only warranty provided by Silvan is set out on the forms accompanying the goods (for a copy please contact the Silvan Customer Service Centre). No other warranty or representation is made by Silvan. The terms of Silvan's warranties are subject to the operation of any law including the Australian Consumer Law.

CANCELLATIONS

1. Cancellations made on the day the order was placed:
 - a. If stock isn't dispatched, no handling fee applies
 - b. If stock has been dispatched a restocking fee applies
2. Cancellations made after the day the order was placed, a restocking fee will apply.

RETURNS POLICY

1. Before returning any product to Silvan, a Return Authorisation (RA) Number and approval form must be obtained from Silvan Customer Service. Goods WILL NOT be accepted without an RA number and form.
2. All returns must be requested within 14 days of the invoice date.
3. Goods will only be accepted for credit if they are stock items (i.e. excludes obsolete and indent only items), returned undamaged and in a saleable condition.
4. Return freight will be paid by the Customer if the goods are returned at the Customer's volition, unless authorised by the Company in writing prior to return of the goods.
5. Written claims must reference Silvan invoice numbers, and must be dated and state the reason for the claim.
6. A restocking fee will be applied if the goods have been dispatched according to the order.
7. Return of products valued under \$75 (Excl. GST) won't be accepted if dispatched according to the order.

CLAIMS

Pricing & Freight Claims need to be made within 14 days of the invoice date. Any claims after this for pricing discrepancies will not be accepted. Claims for Freight Damage need to be made within 14 days of the invoice date by notifying Silvan Customer Service. Claims received after this will not be accepted.

DISCOUNT CODES

Refer to individual Trading Terms for specific discounts.

FOR A FULL LIST OF TERMS & CONDITIONS, PLEASE VISIT WWW.SILVAN.COM.AU/TERMS



Spraying Equipment

Product Guide 2026-27



SILVAN AUSTRALIA PTY. LTD. ABN 48 099 851 144

Head Office: 68 Atlantic Drive, Keysborough, Victoria 3173

QLD. Office: Warehouse 2, 30 Gow Street, Moorooka, Queensland 4105

W.A. Office: 12 Cressall Road, Balcatta, Western Australia 6021

Freecall: 1300 SILVAN | Fax: 1800 SILVAN

Email: info@silvanaust.com | Web: silvan.com.au

The company reserves the right to change recommended prices and specifications without notice. All items in this catalogue have been included in good faith on the basis that the goods described were available at the time this book was published. Failure of suppliers to deliver in accordance with samples, descriptions, or at all, or other unintentional causes may result in some lines being unavailable. Space may prevent some dealers from stocking all items. All brand names and product names used in this publication are trade names, registered trade marks, or pending trade marks of their respective owners.

For more information call 1300 745 826 or visit www.silvan.com.au